

# Stormwater Soakage and Groundwater Recharge in the Auckland Region

Guideline Document 2021/007 Version 1





# Stormwater Soakage and Groundwater Recharge in the Auckland Region

2021

Auckland Council

Guideline document GD2021/007

ISSN 2230-4541 (Print)

ISSN 2230-455X (Online)

ISBN 978-1-99-100228-0 (Print)

ISBN 978-1-99-100229-7 (PDF)

---

Reviewed and recommended for publication by:

---

Name: Branko Veljanovski

Position: Head of Engineering Design and Asset Management

---

Approved for publication by:

---

Name: Paul Klinac

Position: General Manager, Technical Services

---

Recommended citation:

Montakhab, A., Cunningham, A., & Roberts, R. (2021). Stormwater soakage and groundwater recharge in the Auckland region. Auckland Council guideline document GD2021/007

© 2021 Auckland Council

Auckland Council disclaims any liability whatsoever in connection with any action taken in reliance of this document for any error, deficiency, flaw or omission contained in it.

This publication is provided strictly subject to Auckland Council's copyright and other intellectual property rights (if any) in the publication. Users of the publication may only access, reproduce and use the publication, in a secure digital medium or hard copy, for responsible genuine non-commercial purposes relating to personal or public service, provided that the publication is only ever accurately reproduced and proper attribution of its source, publication date and authorship is attached to any use or reproduction. This publication must not be used in any way for any commercial purpose without the prior written consent of Auckland Council. The use of this publication for professional training purposes, regardless whether payable or free of charge, also requires Auckland Council's prior written consent. Auckland Council does not give any warranty whatsoever, including without limitation, as to the availability, accuracy, completeness, currency or reliability of the information or data (including third party data) made available via the publication and expressly disclaim (to the maximum extent permitted in law) all liability for any damage or loss resulting from your use of, or reliance on the publication or the information and data provided via the publication. The publication, information, and data contained within it are provided on an "as is" basis.

## Acknowledgements

This document was prepared with technical input from Auckland Council and industry experts including, but not limited to the following individuals:

### Authors

Dr Amir Montakhab, Amelia Cunningham, and Ross Roberts

### Contributors

Project management: Dr Amir Montakhab

Technical content: Glenn Broadbent, Scott Paton, Jason Ng, Phillip Johansen, Kura Taraare, Daniel Reeves, Rajinesh Kumar, Inthan Azoor, Dean Yee, and Andrew Irvine.

Editorial: Janet MacKinnon

A preliminary review of the draft document has been carried out by Water New Zealand. The feedback from the following individuals has been incorporated: Sian France, Ann Williams, Michael Hannah, Peter Mitchell, Alan Pattle, and Glenn Richmond.

Thanks are also extended to industry professionals who contributed to this document including, but not limited to, Roger Seyb, Kevin Jonathan, Ian Shaw, Noel Roberts, Tania Shaw, and Gerald Strayton.

Special thanks are also extended to following people who contributed to this work: Bastogne-Zhiyuan Lu, Paige Harris, Ally Bodmer, Mathew Chandran and Zihao Lin.

Thanks also to Auckland Council staff, both past and present, and industry experts who contributed to the development of the guideline. This document is based on Auckland Council's Technical Report 40 (TR2013/40) '*Stormwater Disposal via Soakage in the Auckland Region*, (Auckland Council, 2013). The project team acknowledges the work undertaken by many individuals and organisations over the years to provide technical content for this document.



# Preface

## What is the purpose of this document?

This guideline document, *Stormwater Soakage and Groundwater Recharge in the Auckland Region* (Guideline Document 2021/007 or GD07) provides detailed design guidance for soakage and groundwater recharge devices in Auckland. It is aligned with Auckland Unitary Plan requirements to achieve a resilient and sustainable outcome utilising the principles of water sensitive design.

The focus is on the design of soakage devices that either:

- Manage the impact of stormwater quantity by disposing of stormwater to the ground (primary stormwater systems), or
- Recharge groundwater in peat soil to avoid drawdown-induced settlement (groundwater recharge systems).

GD07 is an update of Technical Report 2013/040 - *Stormwater Disposal via Soakage in the Auckland Region*, and will supersede that document once it is included in the Auckland Council Stormwater Code of Practice. It aims to provide user-friendly technical design guidance for developers, designers and regulators based on current best practice specific to the requirements of the Auckland Unitary Plan.

GD07 has been prepared for use in the Auckland region. While many of the principles are universal and can be used elsewhere, the technical specifications have been developed for the geology, geography, climate, receiving environments and context of Auckland. Auckland Council, therefore, disclaims any responsibility for the use of GD07 outside of the Auckland region.

## What new inclusions and approaches are in this guideline document?

The key new approaches in this document, relative to Technical Report 2013/40 *Stormwater disposal via soakage in the Auckland region* (Auckland Council, 2013), are:

- Alignment with the requirements of the Auckland Unitary Plan (Auckland Council, 2018)
- Alignment with the NZ Ground Investigation Specification (Ministry of Business, Innovation and Employment & New Zealand Geotechnical Society, 2017)
- Alignment with the Auckland Council Stormwater Code of Practice
- The Inclusion of climate change and best practice design guidance for soakage devices
- Additional guidance on other device design considerations such as safety in design.

## How was this guideline document developed?

A comprehensive review of national and international soakage management and control guidelines was carried out to identify current best practice procedures and guidelines. This was accompanied by analysis which identified gaps and issues within currently used guideline documents, including:

- Technical Report 2013/040 *Stormwater Disposal via Soakage in the Auckland Region* (Auckland Council, 2013)
- Auckland City Council's *Soakage Design Manual* 2003 (Auckland City Council, 2003)
- Papakura District Council Development Code (Papakura District Council, 2010).

Meetings were held with Auckland Council staff involved in engineering, resource consenting and stormwater disposal in soakage areas.

**Who was consulted in the preparation of this guideline document?**

Several stages of the consultation were undertaken in the development of this guideline, including:

- Internal workshops and consultation with Auckland Council's stakeholders
- External consultation with, and input from, the industry through a focus group of recognised stormwater practitioners, contractors and council/government staff who regularly use the TR2013/40 manual.

**Future revisions**

Auckland Council intends to provide future revisions to this guideline periodically in response to changes in legislation, policies, technologies, national standards, and feedback from the industry. Feedback on GD07 can be sent to [wsd@aucklandcouncil.govt.nz](mailto:wsd@aucklandcouncil.govt.nz) using the feedback form on the Auckland Design Manual website.

## List of abbreviations

Abbreviation	Definition
AEP	Annual exceedance probability
AUP	Auckland Unitary Plan
GD	Guideline document
GIS	Geographic information systems
GPT	Gross pollutant trap
IANZ	International Accreditation New Zealand
OSM	On-site stormwater management
O&M	Operation and maintenance
NDC	Network discharge consent
RMA	Resource Management Act
SMAF	Stormwater management areas – Flows 1 & 2
TP	Technical publication
TR	Technical report
SWCoP	Code of Practice for Land Development and Subdivision Chapter 4 – Stormwater.

## List of units and equation nomenclature

	Unit	Description
A	m <sup>2</sup>	Area
A <sub>(device)</sub>	m <sup>2</sup>	Base area of storage pit and additional storage
A <sub>(impervious)</sub>	m <sup>2</sup>	Contributing impervious area
A <sub>(req)</sub>	m <sup>2</sup>	Minimum required surface area for soakage
A <sub>(S)</sub>	m <sup>2</sup>	Available surface area for soakage
A <sub>(T,actual)</sub>	m <sup>3</sup>	Actual volume soakage area of trench in recharge pit design
A <sub>(T,min)</sub>	m <sup>3</sup>	Minimum required soakage area of the trench in recharge pit design
AEP	%	Annual exceedance probability
C <sub>(req)</sub>	m <sup>3</sup> s/L	Coefficient of required volume
C <sub>(storage)</sub>		Discharge rate for storage expressed as a proportion of peak discharge rate
CN		Curve number
d <sub>(device)</sub>	m	Depth of storage pit and additional storage
d <sub>(S)</sub>	m	Depth of soakpit
d <sub>(T)</sub>	m	Depth of trench in recharge pit design
F <sub>(total)</sub>		Total factor of safety
F <sub>(c)</sub>		Factor of safety representing consequences of failure
F <sub>(u)</sub>		Factor of safety representing testing uncertainty
L <sub>(S)</sub>	m	Length of soakpit
Ø <sub>(soakpit)</sub>	%	Porosity or void space in soakpit
Ø <sub>(storage pit)</sub>	%	Porosity or void space of storage pit material
Ø <sub>(trench)</sub>	%	Porosity or void space of trench material in recharge pit design
P <sub>(factored)</sub>	L/min/m <sup>2</sup>	Tested soakage rate with factor of safety applied
p <sub>(factored)</sub>	L/s	Total soakage rate of the device with factor of safety applied
p <sub>n</sub>	L/s	Soakage rate of the n <sup>th</sup> borehole with factor of safety applied
Q <sub>(S)</sub>	L/s	Peak flow rate from the contributing catchment
S	mm	Potential soil storage
T <sub>(drain)</sub>	hr	Time to drain the stored volume
V <sub>(add)</sub>	m <sup>3</sup>	Net additional storage volume, if any
V <sub>(device)</sub>	m <sup>3</sup>	Gross volume of storage pit and additional storage
V <sub>(impervious)</sub>	m <sup>3</sup>	Runoff volume from impervious area
V <sub>(req)</sub>	m <sup>3</sup>	Required storage volume
V <sub>(soakpit)</sub>	m <sup>3</sup>	Available storage volume in soakpit
V <sub>(storage pit)</sub>	m <sup>3</sup>	Required gross volume of storage pit
W <sub>(S)</sub>	m	Width of soakpit



## List of definitions

Symbol	Definition
<b>Annual exceedance probability (AEP)</b>	The probability of a natural hazard event (usually a rainfall or flooding event) occurring annually, usually expressed as a percentage. Bigger rainfall events occur (are exceeded) less often and will therefore, have a lesser annual probability.
<b>Detention</b>	Water that enters a stormwater device and is temporarily detained, before being slowly released.
<b>Groundwater flow</b>	Movement of water through the saturated zone below the water table.
<b>Groundwater recharge soakpit</b>	A device used to reduce the risk of drawdown induced settlement, particularly in areas with peat soil.
<b>Infiltration</b>	The process of water entering the soil.
<b>Infiltration rate</b>	The rate at which water enters into the soil. It depends on soil texture (size of the soil particles) and soil structure (arrangement of the soil particles), crusts or films and head (water depth).
<b>Percolation</b>	Water movement through the soil driven by gravity.
<b>Piezometer</b>	A device used to monitor groundwater levels.
<b>Pre-treatment</b>	Treatment of water before it enters the soakage device to mitigate contamination and pollution.
<b>Pre-treatment device</b>	This is used to remove pollutants that may affect the device's performance.
<b>Primary systems</b>	These include both open and closed conduits and shall be designed to cater for the flows generated by the event specified in the Code of Practice for Land Development and Subdivision Chapter 4 – Stormwater.
<b>Retention</b>	Reducing the volume of runoff through infiltration/reuse on-site.
<b>Secondary systems</b>	Secondary stormwater systems consist of ponding areas and overland flow paths with sufficient capacity to transfer the flows generated by the event specified in the Code of Practice for Land Development and Subdivision Chapter 4 – Stormwater.
<b>Sedimentation</b>	The settlement of solids within a water body by gravity.
<b>Setbacks</b>	A horizontal setback is a minimum distance from which a structure, in this case the soakage/ groundwater recharge device, would need to be set back from a building, road, river, stream or any other place deemed to require protection.
<b>Slope</b>	The rise or fall of the land surface. Refer to the equal area method found in TP108 to calculate the slope required for hydrology calculations.
<b>Soakage area</b>	An area with suitable ground conditions for soakage. An indicative map showing potential soakage areas is available on Auckland Council GeoMaps. However, soakage areas are not necessarily coincidental with, or limited to, those shown on GeoMaps. A suitably qualified and experienced person is responsible for determining whether a site is in a soakage area.
<b>Stormwater soakpit</b>	On-site stormwater device designed to cater for design storms through infiltration generally used in permeable soil. The term can be used interchangeably with 'soakhole' and 'soakpit'.

Symbol	Definition
<b>Suitably qualified and experienced person</b>	A person who can provide sufficient evidence to demonstrate their suitability and competence.
<b>Runoff</b>	The movement of water above ground (overland flow processes) and may include stormwater, but also water from exfiltration (such as seepage or groundwater surfacing).
<b>Rockbore</b>	Stormwater device designed to cater for design storms through infiltration generally used in fractured rock.
<b>Underground infrastructure</b>	Underground watermains and wastewater network.
<b>Underground services</b>	Elements of a building service, which may include utilities such as lines for telecommunication, electrical cable, or pipes, which are buried in the ground.
<b>Water table</b>	This is the surface where water pressure head is equal to atmospheric pressure. The ground may be saturated above this level (e.g., in clays) due to capillary action. A borehole with an open standpipe will usually exhibit standing water at this level.

# Contents

Preface .....	iii
List of abbreviations .....	v
List of units and equation nomenclature .....	vi
List of definitions .....	vii

## SECTION A INTRODUCTION

A.1.0	Introduction .....	1
A 1.1	Aim of this guideline document.....	1
A 1.2	Scope and application of this guideline document .....	2
A 1.3	How to use this guideline.....	2
A 1.4	Auckland’s regulatory framework for soakage devices and groundwater recharge.....	3
A 1.5	Auckland Unitary Plan: Auckland-wide policies.....	4
A 1.6	Auckland Unitary Plan: Overlays .....	4
A 1.7	Auckland Unitary Plan: Precincts.....	5

## SECTION B DESIGN PROCESS FOR SOAKAGE DEVICES

B.1.0	Introduction .....	7
B.2.0	Design process for soakage .....	7
B 2.1	Project scoping .....	9
B 2.2	Understand the site.....	9
B 2.3	Define the hydrological design requirements .....	12
B 2.4	Device design .....	14
B 2.5	Selection of soakage device .....	14
B 2.6	Geotextiles .....	16
B 2.7	Safety in design .....	17
B 2.8	Lifecycle cost considerations .....	17
B 2.9	Operation and maintenance .....	18
B 2.10	Vesting .....	19
B.3.0	Geology and soakage capacity.....	20
B 3.1	Overview .....	20
B 3.2	Sedimentary rocks and residual soils .....	20
B 3.3	Recent sedimentary deposits .....	21
B 3.4	Fill .....	21
B 3.5	Volcanic soil and rock.....	21
B 3.6	Peat.....	22
B 3.7	Other soakage areas .....	22
B.4.0	Soakage testing .....	22

B.5.0	Factors of safety for soakage device sizing .....	23
-------	---	----

## SECTION C TECHNICAL GUIDANCE

C.1.0	Soakage into fractured rock: rockbore .....	27
C 1.1	Introduction .....	27
C 1.2	Rockbore system components .....	27
C 1.3	Site considerations .....	30
C 1.4	Rockbore device design .....	31
C 1.5	Device sizing.....	32
C 1.6	Design example .....	33
C.2.0	Soakage into permeable soil: stormwater soakpit .....	36
C 2.1	Introduction .....	36
C 2.2	Stormwater soakpit system components.....	37
C 2.3	Site considerations .....	40
C 2.4	Proprietary soakage devices .....	41
C 2.5	Stormwater soakpit design .....	41
C 2.6	Device sizing.....	42
C 2.7	Aggregate specification for soakpits .....	47
C 2.8	Design example .....	48
C.3.0	Groundwater recharge into peat: groundwater recharge soakpit .....	52
C 3.1	Introduction .....	52
C 3.2	Groundwater recharge soakpit system components .....	52
C 3.3	Site considerations .....	54
C 3.4	Groundwater recharge soakpit design.....	56
C 3.5	Device sizing.....	56
C 3.6	Design example .....	60

## APPENDICES

Appendix A1.0	Soakage testing methodology .....	A-1
Appendix B1.0	Worksheets .....	B-1
Appendix C1.0	On-site management operation and maintenance forms.....	C-1
Appendix D1.0	Drawings .....	D-1

## BIBLIOGRAPHY



## Tables

Table 1: Soakage devices within the scope of the document .....	2
Table 2: Key site considerations.....	9
Table 3: Hydrological design standard .....	13
Table 4: Examples of pre-treatment devices .....	16
Table 5: Suggested partial factor of safety ( $F_{(c)}$ ) for consequences of failure .....	23
Table 6: Suggested partial factor of safety ( $F_{(u)}$ ) for uncertainty in input data.....	24
Table 7: Rockbore design components .....	28
Table 8: Rockbore site considerations .....	30
Table 9: Rockbore design considerations .....	31
Table 10: Parameters for rockbore design example .....	34
Table 11: Stormwater soakpit design components .....	37
Table 12: Stormwater soakpit site considerations.....	40
Table 13: Stormwater soakpit design considerations.....	42
Table 14: Required particle size distribution for drainage pit aggregate .....	47
Table 15: Parameters for soakpit design example .....	48
Table 16: Groundwater recharge soakpit design components.....	53
Table 17: Groundwater recharge soakpit site considerations .....	55
Table 18: Groundwater recharge soakpit design considerations .....	56
Table 19: Parameters for groundwater recharge pit design example .....	60

## Figures

Figure 1: Design process for soakage devices .....	8
Figure 2: Typical soakage device layout .....	14
Figure 3: Key components of rockbore devices .....	28
Figure 4: Rockbore design process.....	33
Figure 5: Stormwater soakpit components .....	37
Figure 6: Chart to determine coefficient of required volume .....	43
Figure 7: Soakpit design process .....	46
Figure 8: Sketch of example soakpit design.....	51
Figure 9: Example schematic of a groundwater recharge soakpit .....	52
Figure 10: Groundwater recharge pit design process .....	59
Figure 11: Sketch of example groundwater recharge pit design.....	61



A yellow tracked excavator is shown in the middle of digging a trench in a large, green grassy field. The excavator's arm is extended, and its bucket is positioned over a pile of dark brown soil. The machine has "HIRE" written on its side. In the foreground, a yellow and black striped safety barrier runs across the frame, with an orange and white traffic cone at the end. The background shows a line of trees under a clear sky. The text "A Introduction" is overlaid in white on the left side of the image.

# A Introduction





## Section A Introduction

### A.1.0 Introduction

#### Soakage systems

Soakage systems are on-site stormwater disposal devices that allow discharge of retained water into the ground. They are Auckland Council's preferred option in areas where satisfactory soakage rates can be achieved and are generally used in high infiltration rate ground types, e.g., fractured basalt rock or highly permeable soil. An indicative map showing potential soakage areas can be found in GeoMaps, Auckland Council's online GIS system<sup>1</sup>. As these are based on variable quality source data, actual soakage potential may differ from that shown, so a suitably qualified and experienced person should be consulted when determining whether a site is in a soakage area or not. Soakage devices could be used as a primary system for stormwater disposal and to cater for design storms to comply with the Code of Practice for Land Development and Subdivision Chapter 4 – Stormwater (SWCoP).

As soakage systems are unsuitable for treating areas with high contaminant-generating activities, they should be used in conjunction with other water-quality treatment devices so that they comply with Auckland Unitary Plan (AUP) stormwater treatment provisions.

Soakage systems should not be confused with infiltration devices which are described in GD01<sup>2</sup>. The infiltration devices in GD01 are primarily designed to provide on-site stormwater mitigation in accordance with AUP's SMAF<sup>3</sup> requirements. Soakage devices that are used for stormwater functions are intended for full design storms, not hydrological mitigation.

#### Groundwater recharge

Groundwater recharge is necessary for areas with peat soil to reduce the risk of settlement due to groundwater lowering. As dewatered peat soil is subject to consolidation and ground surface settlement, GD07 includes a device which is solely for groundwater recharge into peat soil.

### A 1.1 Aim of this guideline document

GD07 provides technical information and guidance for stormwater disposal within Auckland's soakage areas and groundwater recharge in peat soil. Soakage areas are areas with suitable ground conditions for soakage as determined by a suitably qualified and experienced person. Recharge areas are areas with soils that are highly susceptible to settlement when dewatered. In peat soil, it is particularly important to keep groundwater levels from falling as the induced settlement can be irreversible and result in an increase in localised flooding as well as damage to buildings and services.

---

<sup>1</sup> Soakage potential maps in Geomaps are not available at the date of this document's publication

<sup>2</sup> Stormwater Management Devices in the Auckland Region, Guideline Document 2017/001

<sup>3</sup> Stormwater management areas – Flows 1 & 2

## A 1.2 Scope and application of this guideline document

GD07 focuses primarily on hydrologic and hydraulic design considerations for soakage devices and devices solely for groundwater recharge into peat soil. This is presented in Table 1.

**Table 1: Soakage devices within the scope of the document**

Purpose	Site conditions	Device
Stormwater disposal	• Fractured rock	• Rockbore
	• High permeability soil	• Stormwater soakpit
Groundwater recharge only	• Peat soil	• Groundwater recharge soakpit

## A 1.3 How to use this guideline

The guideline consists of the following sections:

<b>Section A</b>	<b>Introduction</b>	<ul style="list-style-type: none"> <li>• Describes the aim, scope, exclusions, and its relation to other guidelines and the regulatory framework.</li> </ul>
<b>Section B</b>	<b>Design process</b>	<ul style="list-style-type: none"> <li>• The design process and methodology including site investigation, infiltration testing, hydrology, constraints, selection of devices and treatment considerations.</li> <li>• Overview of Auckland's geology and a summary of typical permeability and soakage design considerations.</li> </ul>
<b>Section C</b>	<b>Technical design guidance</b>	<ul style="list-style-type: none"> <li>• Specific technical design guidance for a selection of soakage devices suitable for stormwater management and groundwater recharge function. It includes a number of worked examples for different soakage devices and scenarios.</li> </ul>

Users of this guideline are responsible for working within their capabilities, training, and experience, and for seeking the advice and consultation of appropriate experts at all times. If any questions or issues arise, Auckland Council may be able to provide advice and assistance.

The guideline should be read in conjunction with:

- 1) The Auckland Council Code of Practice for Land Development and Subdivision – Chapter 4: Stormwater
- 2) Guideline Document: *Stormwater Management in the Auckland Region*, GD2017/001 (GD01)
- 3) Guideline Document: *Water Sensitive Design for Stormwater*, GD2015/004 (GD04)
- 4) Auckland Unitary Plan and documents contained therein (Auckland Council, 2018)
- 5) The New Zealand Building Act (2004), New Zealand Building Regulations (1992) and New Zealand Building Code
- 6) Auckland Transport Code of Practice
- 7) Auckland Regionwide Network Discharge Consent (Auckland Council, 2019).

Users of GD07 should:

- Consider the AUP objectives, policies, and standards that soakage devices are required to meet under the stormwater disposal rules, overlays and precincts
- Review and follow the design process, undertake site investigations and infiltration testing to determine whether the soakage criteria can be met
- Review specific design requirements of the selected device
- Understand operation and maintenance of the selected device.

#### **A 1.4 Auckland's regulatory framework for soakage devices and groundwater recharge**

The Resource Management Act 1991 (RMA), New Zealand's main piece of legislation for environmental management, promotes the sustainable management of natural and physical resources. The AUP is one mechanism Auckland Council uses to give effect to the RMA. The Plan has three roles:

- 1) It describes how Auckland's natural and physical resources will be managed while enabling growth and development
- 2) It provides a regulatory framework; and
- 3) It is the principal statutory planning document for Auckland.

The AUP consists of many planning layers; overlays, precinct plans, zones, and Auckland-wide rules. A proposed development site may sit within one or a number of overlapping planning layers. Developers need to be aware of the impact overlapping planning layers may have on the activity proposed for the site:

- Overlays take precedence over precinct plans, unless specifically stated otherwise in the precinct plan
- Precinct plans take precedence over zones and Auckland-wide rules regardless of whether the restrictions in the precinct plan are more or less restrictive than the zone or Auckland-wide rule.

There are a number of overlay and Auckland-wide policies which apply to stormwater disposal and groundwater recharge. Specific design and use requirements of soakage devices and groundwater recharge may exist for certain precincts.

Auckland Council holds a Network Discharge Consent for the discharge and diversion of stormwater from the public stormwater network across the region. The consent includes some requirements for stormwater management in relation to soakage and anticipates that design of any devices would be undertaken in accordance with this document. It can be accessed through the Auckland Design Manual website.

The Auckland Council Stormwater Bylaw 2015 was created under the Local Government Act 2002. The purpose of the Bylaw is to regulate land drainage within the Auckland region, which includes the protection of the public stormwater network, maintenance of stormwater devices, and management of ground soakage systems. Section 14 of the Bylaw enables Auckland Council to legally specify controls and require new soakage systems to meet the requirements of the Code of Practice and GD07.

### A 1.5 Auckland Unitary Plan: Auckland-wide policies

Two policies from the AUP Section E1: Water quality and integrated management, are relevant for soakage and groundwater recharge:

- E1.3 (15) *Utilise stormwater discharge to a ground soakage in areas underlain by shallow or highly permeable aquifers provided that:*
- a) *Ground soakage is available*
  - b) *Any risk to people and property from land instability or flooding is avoided*
  - c) *Stormwater quality treatment is implemented to minimise effects on the capacity and water quality of the underlying aquifer system*
  - d) *Discharge to ground soakage is the most effective and sustainable option.*
- E1.3 (16) *Require land use development and drainage systems within areas underlain by peat soil to provide for stormwater discharge to ground soakage that maintains underlying water levels and the geotechnical stability of the peat soil.*

Where practicable, other AUP stormwater policies also aim to progressively reduce existing adverse effects. These policies, outlined in Section E1 (Water quality and integrated management); and E2 (Water quantity, allocation, and use); also apply to soakage areas.

### A 1.6 Auckland Unitary Plan: Overlays

The AUP identifies areas (overlays) with shallow and unconfined aquifers that are susceptible to pollution from sources such as excess fertiliser application or contaminant discharges, e.g., stormwater or sewage. Aquifers need protection as they are important sources of water for rural and industrial purposes, as well as providing base flow to surface streams.

The overlay for *Quality Sensitive Aquifers (D2)* largely overlaps with volcanic aquifers where potential for soakage is high, and a reticulated stormwater network is often non-existent. The potential for contamination is highest in these volcanic aquifers because discharge to the aquifer is the most direct.

The following policies should be considered within quality-sensitive aquifer management areas:

- D2.3 (1) *Recognise the sensitivity of the following aquifers to groundwater contamination and minimise the discharge of contaminants in quality-sensitive aquifer management areas:*
- e) *Rural aquifers: Kaipara Sand, Franklin Volcanic, Drury Sand and Āwhitu Sand*
  - f) *Urban aquifers: Auckland isthmus volcanics (including the Ōnehunga, Western Springs volcanics, Mt Richmond volcanic, Wiri volcanic and Mt Wellington aquifers)*
- (2) *Discourage the discharge of contaminants where they are likely to have significant adverse effects on groundwater quality within quality-sensitive aquifer management areas*
- (3) *Maintain the quality of the Onehunga aquifer as a source of municipal water supply for Auckland and minimise the risk of chemical spills into the ground or stormwater drains in the catchment.*



## A 1.7 Auckland Unitary Plan: Precincts

Some AUP planning provisions and rules are specific to certain areas or developments. These development-specific rules are captured in precinct plans. A number of precincts have distinct rules that require stormwater disposal or groundwater recharge through soakage or infiltration:

- Patumahoe
- Pukekohe Hill
- Takanini
- Three Kings
- Omaha South
- Te Arai North
- Long Bay
- Ardmore 2.

Refer to the AUP Precinct Plans (Chapter I) for specific soakage provisions in precincts.



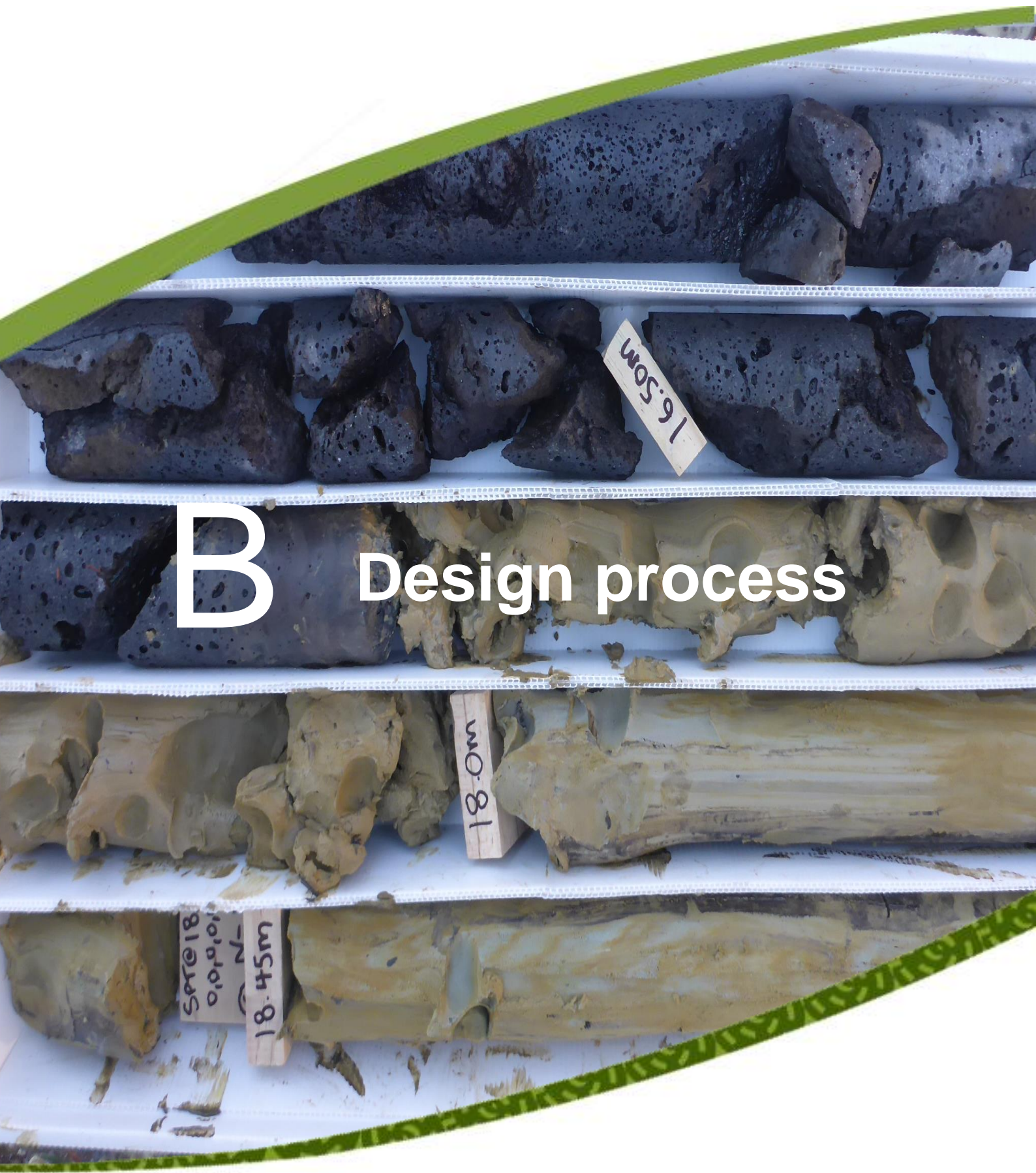

B

Design process

16.50m

18.0m

SAC18  
0.0.0.0.0  
N-  
18.45m



## Section B Design process for soakage devices

### B.1.0 Introduction

This section covers the general process for designing sustainable soakage devices for stormwater disposal and groundwater recharge. It sets out the most efficient way for designers to meet the regulatory provisions that govern Auckland's stormwater disposal in locations that meet ground condition requirements. It also considers opportunities to enhance the receiving environment to meet the requirements set out in the AUP for water sensitive design (water sensitive design is described in GD04<sup>4</sup> and is adhered to by GD01<sup>5</sup> concepts).

Soakage systems must be considered early in the overall design process to ensure the site meets geological requirements as well as the hydrologic needs of the post-development catchment. If designing treatment suites (for stormwater management purposes) for the whole catchment, a comprehensive land planning assessment needs to be undertaken, taking into consideration the proposed development land use and effects on the wider catchment, both upstream and downstream. This is to ensure stormwater disposal is designed for and sits alongside all other aspects of the development. Please refer to the SWCoP for further details.

The recommended first step for most land development projects is a pre-application meeting with Auckland Council to identify a range of consent requirement issues, including those relating to the Engineering Approval process.

#### **Design process for soakage**

Figure 1 shows the recommended design process specific to a soakage device and groundwater recharge pit. Depending on a number of case-specific factors, not all steps will be necessary.

---

<sup>4</sup> Guideline Document 2015/004 Water sensitive design for stormwater

<sup>5</sup> Guideline Document 2017/001 Stormwater management devices in the Auckland region

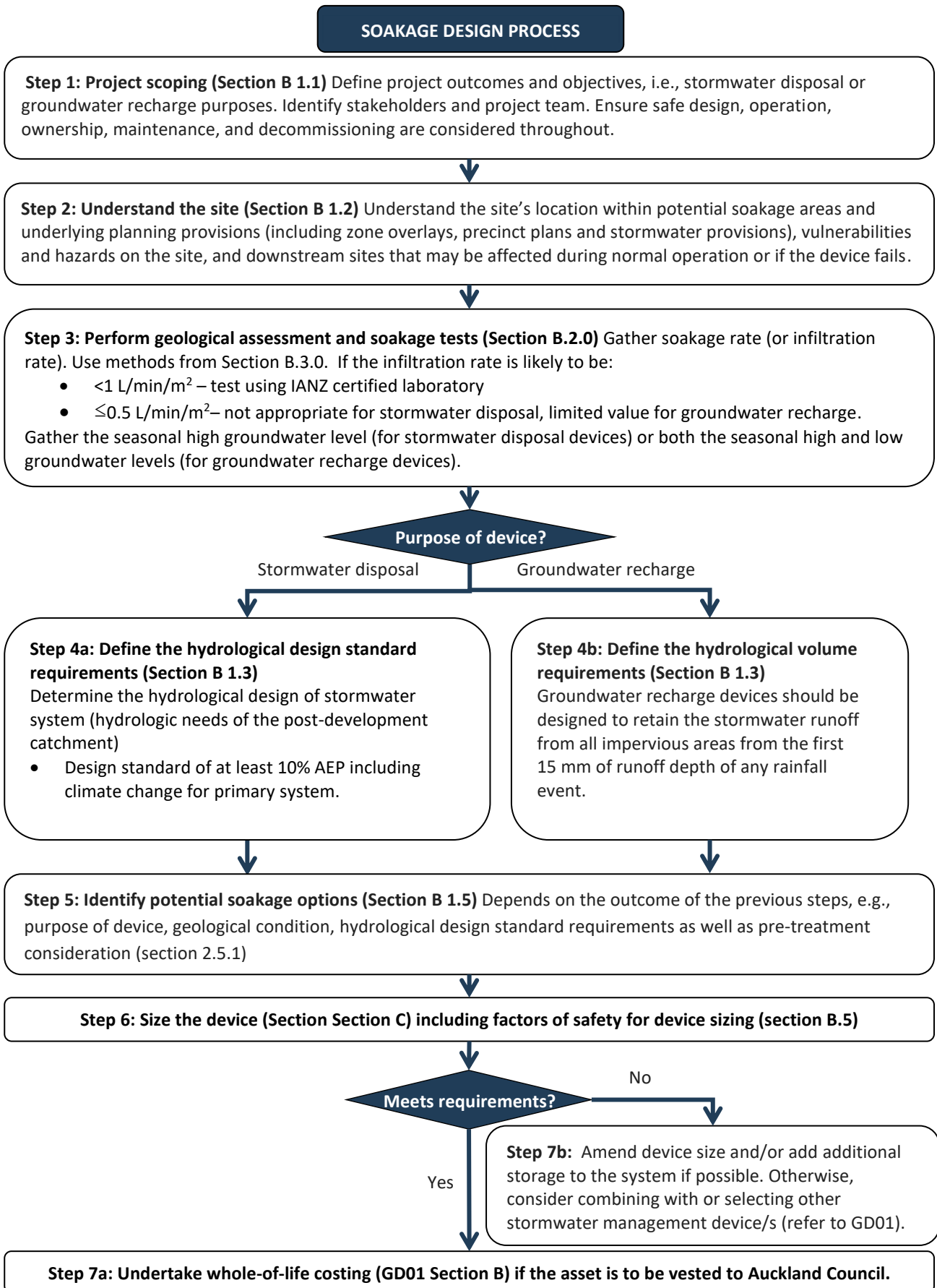

Figure 1: Design process for soakage devices



## B 1.1 Project scoping

Key aspects of the project scoping phase are to:

- Define project outcomes and objectives
- Determine relevant regulatory provisions.

## B 1.2 Understand the site

A comprehensive review of the development site, including historical and proposed land uses, should be undertaken to determine potential issues and opportunities that could impact on the soakage system and/or groundwater recharge pit. Key considerations are summarised in Table 2:

**Table 2: Key site considerations**

Topic	Site considerations	Resources
<b>Catchment size and location</b>	<ul style="list-style-type: none"> <li>• Estimate the catchment size.</li> </ul>	Auckland Council
	<ul style="list-style-type: none"> <li>• The device/s should be positioned within the catchment so that all site runoff for on-site disposal can drain naturally into them.</li> </ul>	GeoMaps
	<ul style="list-style-type: none"> <li>• The device/s shall not be located within the 10% AEP storm flood plain and should be outside of the 1% AEP flood plain, where possible.</li> </ul>	Historical aerial photographs
	<ul style="list-style-type: none"> <li>• Land use of the development, as well as the impervious coverage, must be understood (historic, current, and proposed).</li> </ul>	
	<ul style="list-style-type: none"> <li>• Existing drainage patterns through the site should be understood, including discharge point/s and nearby existing soakage devices.</li> </ul>	
	<ul style="list-style-type: none"> <li>• Overland flow paths through the site and potential flood risks that need to be incorporated into stormwater disposal should be considered. Wherever possible, the device should not be in an overland flow path.</li> </ul>	
	<ul style="list-style-type: none"> <li>• The site's history should be well understood. To provide insight into earlier work undertaken at the site, previous consents can be sourced from Auckland Council.</li> </ul>	
<b>Ground conditions, soakage potential, and soakage rate</b>	<ul style="list-style-type: none"> <li>• Any existing or proposed high contaminant generating car parks and high-use roads (water quality targeted areas) which require treatment before discharge to the soakage device should be identified. Refer to GD01 for treatment options.</li> </ul>	
	<ul style="list-style-type: none"> <li>• Published geology and information from any available nearby geotechnical investigations and/or soakage tests.</li> </ul>	Published geological maps
	<ul style="list-style-type: none"> <li>• Available existing subsurface information regarding subsoil conditions, the thickness of topsoil layers and groundwater conditions.</li> </ul>	Auckland Council GeoMaps
	<ul style="list-style-type: none"> <li>• In most cases, site-specific geotechnical investigations should be undertaken to determine site ground conditions, including soakage tests.</li> </ul>	Property files NZ Geotechnical Database
	<ul style="list-style-type: none"> <li>• The potential for contaminated land to be present on site.</li> </ul>	Aerial photos
<ul style="list-style-type: none"> <li>• Infiltration tests shall be undertaken in conditions representative of winter conditions.</li> </ul>	In-situ testing	



Topic	Site considerations	Resources
<b>Groundwater</b>	<ul style="list-style-type: none"> <li>• Groundwater should be well understood:               <ul style="list-style-type: none"> <li>○ Groundwater quality can be significantly impacted by pollutants and is extremely difficult to remediate. Therefore, prevention is essential</li> <li>○ Groundwater mounding is an important consideration for soakage devices and causes localised increases in groundwater levels.</li> </ul> </li> <li>• Groundwater levels shall be known in the concept design stage:               <ul style="list-style-type: none"> <li>○ Gather the seasonal high groundwater level for the design of soakage devices for stormwater</li> <li>○ All existing groundwater information (both seasonal high and low) should be gathered in cases where there is a need for groundwater recharge into peat soil</li> <li>○ Where information and measurement of the seasonal high groundwater table is not available, and it is not practical to collect this data, an appropriate conservative estimate should be made by a suitably qualified and experienced person based on observations (e.g., colour changes) from test bores and taking into account monitoring data from adjacent sites and waterways. The level of conservatism in the groundwater level assumption should be high, as colour changes in borings could be caused by other factors such as other chemical weathering processes, contamination etc.</li> <li>○ Piezometers should be considered if limited groundwater data is available and if the soakage testing was not undertaken during a period of seasonal high groundwater levels. This should be required for large projects or sites where sensitivity to changes in groundwater is likely to significantly impact on the efficiency of the soakage device, and in the case of centralised devices where the "point" discharge will be significantly higher than many smaller distributed on-lot devices.</li> </ul> </li> <li>• Changes in localised groundwater flow caused by groundwater mounding can affect contaminant discharge direction and spread of neighbouring areas. This is particularly important where significant mounding is possible, such as in areas with lower permeabilities (such as some peats) or where significant stormwater flows are expected to soak. All neighbouring properties that may be affected by groundwater mounding should also be considered.</li> <li>• Potential future changes in groundwater levels should be addressed in the design. These may be caused by climate change (e.g., more intense droughts may lower the seasonal low, more intense storms may raise the seasonal high, and rising sea levels may raise both) or other environmental changes such as changes in land use. At the time of publication there is no particularly relevant guidance available for assessing these changes. It is therefore not expected that designers will undertake detailed hydrogeological studies to assess such changes, except in cases where the consequences may be severe (e.g., large developments on land with shallow groundwater that may be particularly susceptible to future changes).</li> </ul>	<p>GD01 Section C1 0</p> <p>Soils and plants</p>

Topic	Site considerations	Resources
<b>Existing services and structures</b>	<ul style="list-style-type: none"> <li>• Existing public or private stormwater infrastructure in the development area should be understood, including any influencing site conditions that may be affected by any soakage devices.</li> <li>• Often a reticulated stormwater network is not available in areas where stormwater discharges to ground via soakage are feasible.</li> <li>• Existing underground services and infrastructure must be clearly located including water mains, wastewater, gas mains, underground high voltage cables, fibre optic and any nationally or regionally significant underground services. The location and direction of underground services should be noted – bedding material for underground services is often more permeable than surrounding soil and may affect groundwater flows when the water table is raised by soakage.</li> <li>• Groundwater mounding is an important consideration when stormwater runoff from a large area is collected and infiltrated intensively, causing localised increases in groundwater elevation. The risk of groundwater mounding is higher for larger devices but may still occur with smaller devices and can have geotechnical implications including soil softening, buoyancy, and reduced infiltration.</li> <li>• Site boundaries should be reviewed and the impact of the design on existing and neighbouring structures and sites assessed.</li> </ul>	Auckland Council GeoMaps  beforeUdig.co.nz
<b>Design standard for stormwater system</b>	<ul style="list-style-type: none"> <li>• Soakage systems are mainly designed to serve as a primary system and shall be designed to accommodate the 10% AEP design storm event, adjusted for climate change.</li> <li>• Secondary flow path considerations are required when using a soakage device as a primary stormwater system.</li> <li>• Secondary systems for stormwater shall be designed to accommodate the 1% AEP design storm event.</li> <li>• All designs shall meet the requirements of the SWCoP.</li> <li>• Recharge systems take only at the first 15 mm of stormwater runoff depth from impervious areas. A primary system is required to take the remainder of the 10% AEP stormwater flow.</li> </ul>	SWCoP  Development plans
<b>Slopes</b>	<ul style="list-style-type: none"> <li>• Soakage and groundwater recharge devices should not be constructed on steep or unstable slopes, unless a geotechnical engineer or engineering geologist can demonstrate that the device will have no effect on slope stability and will not result in springs further down slope.</li> </ul>	Auckland Council GeoMaps
<b>Contaminated land</b>	<ul style="list-style-type: none"> <li>• Soakage and groundwater recharge devices are not suitable in areas where contamination has occurred, or where chemical spillage may occur: <ul style="list-style-type: none"> <li>○ Contaminated land may pose a risk to the environment, especially when stormwater runoff infiltrates high-quality aquifers.</li> <li>○ Stormwater runoff or groundwater from contaminated land must not be discharged into a soakage device.</li> <li>○ Sediments contained within a device may be considered contaminated at the time of disposal. This may impose a financial burden at the operation stage which should be considered in the design.</li> </ul> </li> </ul>	

Topic	Site considerations	Resources
<b>Upstream extension</b>	<ul style="list-style-type: none"> <li>If an extension into an upstream catchment (e.g., property) with future development potential is required, the soakage device shall be sized to also convey the upstream catchment serviced by the extension, in accordance with the SWCoP.</li> </ul>	
<b>Cut or fill operations</b>	<ul style="list-style-type: none"> <li>If a site has fill (including site-won or imported fill) located within the proposed location of a soakage device, testing must be repeated to demonstrate that the fill achieves the required soakage characteristics. In general, fill performs poorly when subjected to high groundwater levels. The geotechnical stability shall be checked to confirm that the soakage device will not cause geotechnical instability.</li> <li>Where a lot has been subject to cutting, the testing undertaken shall be reassessed to confirm its validity. If the zone tested is no longer representative of the soakage pit zone, the test must be repeated.</li> </ul>	
<b>On-site wastewater disposal</b>	<ul style="list-style-type: none"> <li>If there is on-site wastewater disposal, the soakage and groundwater recharge devices must be designed to avoid having any effect on the wastewater disposal device during normal operation or when overflowing.</li> </ul>	GD06
<b>Access requirements</b>	<ul style="list-style-type: none"> <li>Effective maintenance relies on ready access to the soakage or pre-treatment device, e.g.: <ul style="list-style-type: none"> <li>Rockbores, manholes, pre-treatment devices, and sediment chambers/ catchpits are most effectively cleaned using vacuum-type systems</li> <li>All soakage devices (except rockbores) may eventually require excavation of soil or scoria/gravel layers so that repairs can be made</li> <li>Rockbores may require to be retired and replaced by new rockbores</li> </ul> </li> <li>For this maintenance to be achievable, the location of the device within the site should allow for: <ul style="list-style-type: none"> <li>Access to the device should be at least 2-3 m wide with no overhead structures (i.e., decks / pergolas), to enable entry of a small excavator</li> <li>Alternatively, a proven reserve soakage site with better access may be identified.</li> </ul> </li> </ul>	

### B 1.3 Define the hydrological design requirements

Depending on the device's purpose, the following hydrological parameters should be defined:

- For on-site primary stormwater systems which manage the impact of stormwater quantity by disposing of stormwater to the ground:
  - The design event standard
  - The achievable rate of stormwater disposal through infiltration
- For recharging groundwater in peat soil to avoid drawdown-induced settlement:
  - Retention depths and volumes for first 15 mm of runoff from impervious services.
  - The achievable rate of stormwater disposal through infiltration.

This guideline does not provide details for the hydrologic mitigation requirements to achieve hydraulic neutrality in accordance with the guideline document: *Stormwater Management Devices in the Auckland Region*, GD2017/001 (GD01). For this case, the user should refer to GD01.

### B.1.3.1 Calculate hydrologic design requirements

It is to the responsibility of the designer to determine which design events need to be designed for to meet regulatory requirements. Key hydrologic calculations needed for Auckland's regulatory provisions are presented in Table 3:

**Table 3: Hydrological design standard**

Function	Hydrological calculation	Aim	Preferred method	Calculation requirement	Rockbore <sup>1</sup>	Stormwater soakpit <sup>2</sup>	Groundwater recharge soakpit <sup>3</sup>
Primary stormwater system	Flow for post-development catchment	Stormwater disposal	TP108 SWCoP	10% AEP <sup>4</sup>	✓	✓	–
Groundwater recharge	Retention volume	To avoid drawdown induced settlement	-	First 15 mm of runoff from impervious surfaces	–	–	✓

#### **Notes:**

- 1 Refers to soakage into fractured rock (Section C1.0)
- 2 Refers to soakage into permeable soil (Section C2.0)
- 3 Refers to groundwater recharge into peat (Section C3.0)
- 4 Should be adjusted for climate change according to Stormwater Code of Practice (SWCoP).

#### **Hydrological design of stormwater systems**

If the soakage device is designed as a primary stormwater system, it shall comply with the design event standards described in the SWCoP. All primary stormwater systems shall be designed to cater for design storms of at least 10% AEP, adjusted for climate change, for the post-development catchment. If the soakage device is not sufficient to dispose of all design stormwater runoff through infiltration, the designer could consider treatment suites or detention to achieve the requirements.

Development is generally not permitted in areas with no secondary flow path. Secondary systems shall be designed to accommodate the 1% AEP design storm event.

#### **Hydrologic volume requirements for groundwater recharge**

Groundwater recharge should be designed to retain stormwater runoff from all impervious areas for the first 15 mm of runoff depth of any rainfall event. The primary purpose of the groundwater recharge soakpit device is to avoid drawdown induced settlement, particularly in peat soil areas. Stormwater disposal is not the primary purpose.

## B 1.4 Device design

Soakage and groundwater recharge devices are systems to provide stormwater disposal and groundwater recharge through infiltration (Figure 2). Consideration needs to be given to the removal of sediment and/or contaminants before the flow enters the soakage device and this will primarily be dependent on the catchment and its potential contaminant sources. Overflow drainage should be designed to divert flow into an approved outlet (i.e., stormwater systems or overland flow paths) in case of media blockage.

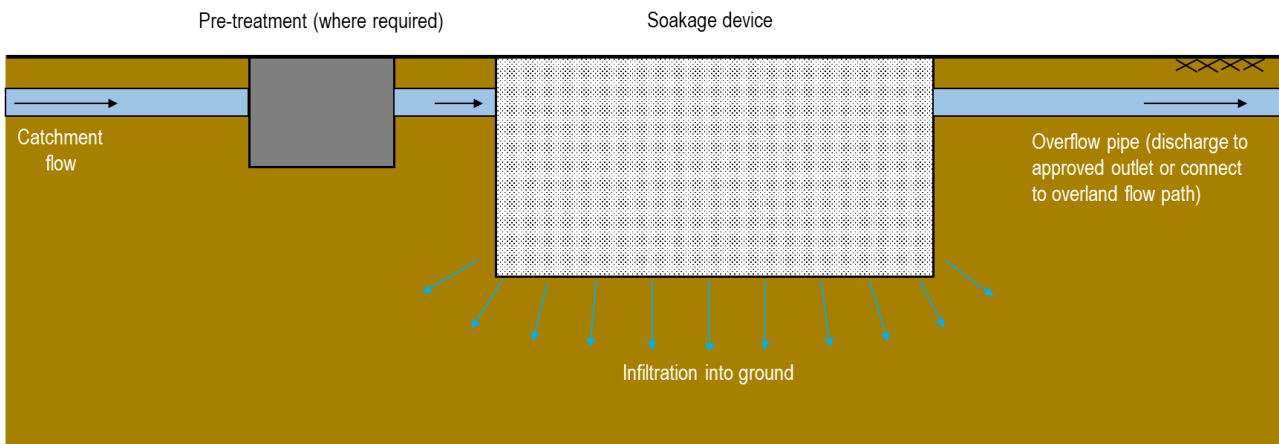

Figure 2: Typical soakage device layout

## B 1.5 Selection of soakage device

GD07 provides details and specifications for two main functions: stormwater disposal and groundwater recharge. Soakage devices may be used in areas with ground conditions of fractured rock, and permeable soil with a high infiltration rate. Depending on ground conditions and required function, the following devices presented in this guideline may be appropriate:

- Soakage into fractured rock: Rockbores
- Soakage into permeable soil: Stormwater soakpit
- Groundwater recharge into peat: Groundwater recharge soakpit.

Each development area will have unique characteristics which will guide the designer's choice of device/s. In addition, individual devices have minimum specifications which dictate where and when they can be used. It is important to determine the limitations of the site, such as ground conditions, as well as the benefits and constraints of each device. These considerations will be used in the analysis and selection of an appropriate solution.

Key considerations when choosing devices include:

- Function of the device, i.e., stormwater disposal or groundwater recharge
- Effectiveness in achieving hydrological requirement for stormwater
- The optimal number and types of devices needed to meet the site's stormwater disposal needs
- Costs, including maintenance and renewal costs
- Safe design for construction, operation, maintenance and decommissioning

- Long-term performance
- Maintenance, including access, replacement parts not subject to licenses or other restrictions
- Ownership (refer to the SWCoP)
- Connection to the public stormwater system (refer to the SWCoP)
- Maximising benefits over the long term
- Geology
- Groundwater level.

### **B.1.5.1 Pre-treatment**

Pre-treatment devices are structures that are designed to be installed upstream of soakage systems to remove contaminants, litter, and sediment from stormwater flows to protect the soakage device from clogging and the aquifer from contaminants. There is a distinction between measures aimed at avoiding clogging to minimise maintenance requirements, and stormwater treatment to target contaminants such as heavy metals, total suspended solids, and hydrocarbons. It is up to the designer to determine which pre-treatment device is needed based on catchment characteristics (sediment load, gross pollutants, water quality, etc), with consideration for minimising maintenance requirements.

#### **Anti-clogging**

Anti-clogging measures such as sediment chambers, catchpits, litter traps or leaf separators should be incorporated in the design of all soakage and groundwater devices to minimise maintenance requirements and ensure long-term operation.

#### **Stormwater treatment**

Stormwater treatment is required upstream of soakage devices where stormwater run-off includes carparks and roads, or to treat other potential contaminants such as hydrocarbons, etc. Pre-treatment options include proprietary filters, oil/water separators, gross pollutant traps, bioretention devices (rain gardens, vegetated swales, tree pits), etc. Option selection should be based on the contaminants that may be generated within the soakage device's catchment.

Pre-treatment may be a requirement to meet the AUP rules, i.e., a water quality targeted area (high contaminant generating areas such as carparks and high-use roads). In these cases, the soakage device must be designed in combination with a stormwater treatment device in accordance with the guideline document: *Stormwater Management in the Auckland Region*, GD2017/001 (GD01). The detailed design of stormwater treatment devices does not form part of this guideline. For this topic, the user should instead refer to GD01.

#### **Examples of pre-treatment devices**

There are a number of pre-treatment devices available to prevent clogging of the soakage device and protect the aquifer from contaminants, depending on the type of catchment and its potential contaminants. Table 4 provides examples of pre-treatment devices and their intended purpose:

**Table 4: Examples of pre-treatment devices**

Runoff source	Examples of pre-treatment devices	Purpose	Design guidance
High contaminant generating areas including carparks and roads <sup>1</sup>	<ul style="list-style-type: none"> <li>Gross pollutant traps</li> <li>Stormwater treatment devices as per GD01</li> <li>Proprietary filter devices</li> <li>Oil/water separators</li> </ul>	<ul style="list-style-type: none"> <li>Water quality treatment to protect the receiving aquifer</li> <li>Anti-clogging</li> <li>Prevents sediment and gross pollutants from entering soakage device</li> <li>Removal of hydrocarbons, oils, grease, etc.</li> </ul>	Auckland Transport GD01
Residential paved area	<ul style="list-style-type: none"> <li>Sediment chamber or catchpit upstream of the soakage device</li> </ul>	<ul style="list-style-type: none"> <li>Anti-clogging</li> <li>Removes gross solids and provides for sedimentation preventing coarse and suspended solids from entering the soakage device</li> </ul>	Auckland Transport Building Code E1
Residential roof area	<ul style="list-style-type: none"> <li>Leaf separator on downpipe (or equivalent such as hedgehog or wire netting in spouting)</li> <li>Sediment chamber or catchpit upstream of the soakage device</li> </ul>	<ul style="list-style-type: none"> <li>Anti-clogging</li> <li>Removes gross solids, sediment, and organic material to prevent blockage of soakage device</li> </ul>	Manufacturer's specifications

<sup>1</sup>If the catchment is a high contaminant generating area as defined in the AUP, treatment in accordance with GD01 is required. However, to protect the soakage device, additional treatment may be needed, e.g., gross pollutant trap plus rain garden prior to entering the soakage device.

## B 1.6 Geotextiles

Geotextiles should be used for soakpits and recharge pits to form a barrier between the soakage device media and surrounding soils. The geotextile should wrap the soakage device and reduce migration of native soil particles into the soakage media while allowing stormwater to pass into the surrounding soils.

### Key considerations for geotextile design:

- Lightweight, non-woven, with minimum Class C strength and Class 1 filtration capacity (based on Transit New Zealand F/7: 2003 *Specification for Geotextiles* and the Transit New Zealand F/7 *Notes to the Specification for Geotextiles*)
- Not to be used between soakage media
- Sub-base should be prepared to be free of sharp rocks, roots, and any other materials; the subgrade should be smooth and level, but not compacted or rolled as this will reduce permeability
- All overlaps should meet minimum requirements specified by geotextile supplier, but not less than 300 mm
- Geotextile should be secured in place with staples, pins, or sandbags on the horizontal sections. Make sure the geotextile is secured along edges and overlaps.



## B 1.7 Safety in design

Design of all soakage and groundwater recharge devices shall take account of health and safety risks throughout the life of the device and promote the safety of Auckland Council employees, contractors, the public, property, and operating personnel. Designers, architects, engineers, manufacturers, and suppliers or installers also hold a duty of care under the Health and Safety at Work Act and are required to consider all aspects of risk during all phases of a device's life, including design, construction, operation and decommissioning. Operational risks shall be considered during both normal uses and in extreme storm events.

Operation and maintenance activities often involve personnel working within live networks. Design engineers shall ensure that all practicable measures are included in the design to facilitate safe working conditions in and around the device.

As these devices tend to be developed in urban areas, to ensure public safety, careful consideration is also needed in design and construction with respect to how the public may interact with them. Ensuring that the device is safe both for the public, and operational and maintenance staff is critical. It is the designer's obligation to identify hazards throughout the life of the soakage and groundwater recharge system and take all reasonable steps to eliminate them in the design process.

Some safety considerations for these devices include:

- Consideration for all works in enclosed spaces, i.e., safe access into the inspection manhole / detention manhole for inspection and maintenance should be designed for; noting that entry into a manhole is considered to be confined space entry
- Access to the device should be within safe and easy reach for maintenance (including sediment removal), renewal and decommissioning
- Maintain ingress and egress routes to design standards
- Consideration of potential tripping and falling hazards
- Mowing considerations (such as slopes)
- Where a device is connected into roof water, guttering may get clogged reducing water flows into the device and may require periodic cleaning. Fall prevention measures should be in place to reduce risk during this maintenance
- Ability to assess the need for maintenance of the device without requiring specialist skills or entering confined spaces.

## B 1.8 Lifecycle cost considerations

Lifecycle costing is the sum of the acquisition and ownership costs of an asset over its lifecycle from design, manufacturing, usage, and maintenance, through to disposal.

A whole-of-life timeframe is warranted because future costs associated with the use and ownership of an asset are often greater than the initial acquisition cost and may vary significantly between alternative solutions to a given operational need (Australian National Audit Office, 2001). Therefore, it is essential to complete the lifecycle cost exercise during the concept design for all options.

A full lifecycle cost analysis must be undertaken for any device vested to Auckland Council (see the SWCoP). In all instances, lifecycle costs must be discussed in detail with the future asset owner.

A further description of lifecycle cost is provided in GD01 and generally applies to all stormwater management that could apply for the soakage devices. It is not specifically addressed here.

### B 1.9 Operation and maintenance

This section provides high-level considerations and is not exhaustive. Operation and maintenance requirements of individual devices shall comply with all relevant codes, standards, and guidelines, including, but not limited to:

- Auckland Council TR 2010/052 *Construction of Stormwater Management Devices in the Auckland Region*
- Auckland Council TR 2010/053 *Operation and Maintenance of Stormwater Management Devices in the Auckland Region*.

The following operation and maintenance considerations need to be addressed during design and specification:

- As-built drawings must be prepared
- A cost-effective Operation and Maintenance Plan must be developed prior to asset transfer including traffic management (if required), e.g., long service-life with consideration of maintenance
- A Monitoring Plan must be prepared which details what monitoring is needed and its frequency
- Soakage devices clog very easily but are difficult to refurbish. Maintenance should, therefore, be preventative with care taken to ensure pre-treatment devices are regularly inspected and maintained
- Where a new structure, e.g., an underground chamber, will create a “confined space” as defined in AS 2865: *Confined space* (Standards Australia, 2009), the design engineer shall provide full details of how risk to personnel during construction and future maintenance shall be managed
- Devices to be vested to Auckland Council shall meet SWCoP requirements. Key considerations include:
  - Draft Operation and Maintenance Manuals must be submitted to Auckland Council for approval. The manuals should describe the device’s design objectives and all major features, explain operations such as recommended means of sediment removal and disposal, identify key design criteria and ongoing management and maintenance. Accurate design calculations shall be included in the manual
  - It shall be demonstrated that any spare parts, anticipated as being required for routine maintenance activities, are commonly available on the open market and are not subject to any licences or other restrictions that would bind Auckland Council to purchase such items from a single supplier
  - Easements should be secured to provide facility and maintenance access (for public facilities, where located in private land).

### B.1.9.1 Operational requirements

The primary operational requirement of a soakage device is to maintain soakage rates at or above the design level of service flow rate. Clogging due to sediment and debris ingress is a problem as it is difficult to rehabilitate soakage once clogging has occurred. Sediment in rockbores can be caught in fractures and fissures in the rock, while sediment in soakpits can be caught within the pit media or filter cloth. Restoring the soakage rates of a clogged device can require significant maintenance work such as replacement of the media, hydro-jetting the rockbores or redrilling rockbores. These maintenance measures are often not completely effective. Experience has shown that redraining rockbores is more successful compared to hydro-jetting.

### B.1.9.2 Owner's obligations

An Operation and Maintenance Manual including procedures, initial settings, specific requirements for operation, and a maintenance schedule, should be prepared for soakage devices in accordance with Auckland Council requirements. The procedures given below should be compiled at either building consent stage for private assets, or engineering process approval for public assets.

Soakage, groundwater recharge, overflow pipe/overland flow path and pre-treatment devices should not be modified or removed without Auckland Council approval. The owner should carry out the following tasks for all devices:

- Complete and submit the standard form “On-site stormwater management – operation and maintenance plans” to Auckland Council along with a schematic drawing of each device (refer to Appendix C)
- Carry out periodic inspections, as detailed in the device-specific plans. Keep inspection records to track the progressive development of device/s over time (refer to worksheet template in Appendix C for all devices)
- Carry out annual inspections to check for build-up of sediment in the system as per advice in Operational and Maintenance Plan standard forms.

All operations are to be carried out safely. Particular care should be taken with confined spaces found in rockbores. Entry to confined spaces can be dangerous and should only be attempted by suitably qualified people. In general, operations should be undertaken according to the Australian Standard AS 2865-2009 *Confined spaces* (Standards Australia, 2009).

## B 1.10 Vesting

All soakage and groundwater recharge devices being vested to Auckland Council shall comply with the Auckland Council Code of Practice and Building Code requirements. They require Engineering Plan Approval including Operation and Maintenance Plans.

Also, any devices that will be vested in Auckland Transport shall be designed in accordance with the Auckland Transport Code of Practice (Auckland Transport, 2017).

The Operation and Maintenance Plan and Maintenance Records must be submitted to Auckland Council prior to vesting. Maintenance of stormwater disposal devices shall be considered early in the design process to facilitate the ease and efficiency of their on-going operation and maintenance.

Devices shall be located in a readily accessible location, preferably on public land or land to be vested with Auckland Council. Where this is not possible, and the device is located in private land, easements are to be provided for maintenance and access. Generally, the location of stormwater disposal devices in trafficked locations is not acceptable. Deviations from this approach may be considered by Auckland Council, e.g., where the device is in a very low traffic volume location, access is on the berm rather than the carriageway, and there is sufficient area. Device location, type, size, and maintenance requirements are subject to Auckland Council's approval.

## B.2.0 Geology and soakage capacity

### B 2.1 Overview

Soakage device effectiveness depends upon the capacity of the surrounding ground to accept stormwater. Ground conditions at a site (including consideration of the geology, topography, stability, groundwater levels and permeability of the ground) are a key initial consideration when assessing the viability and effectiveness of a soakage device.

More information can be found in specialist textbooks and geological maps published by GNS Science. Geology of the Auckland region is mapped at a scale of 1:250,000 (Edbrooke, 2001) and the Auckland urban area is mapped at a scale of 1:50,000 (Kermode, 1992). The presence of suitable geological units in the Auckland region can be identified by reference to the soakage potential maps based on regional geological maps. These maps are also reproduced in GeoMaps, Auckland Council's online GIS system<sup>6</sup>. Geological maps are approximations and do not indicate where units exist below the surface. They are appropriate for use as a high-level screening tool but are not suitable for site-specific assessments. A suitably qualified and experienced person is responsible for determining whether a site is in a soakage area.

It is important to characterise the underlying geology with site-specific investigations and test the soakage potential of the soil and/or rock encountered to determine if soakage is a feasible solution. This should include testing the soakage potential and measuring the groundwater level at the specific location of the proposed soakage device.

### B 2.2 Sedimentary rocks and residual soils

Most of Auckland is underlain by weak sedimentary rocks that are weathered at the surface ("residual soils"). These weathered materials typically have low permeability and are therefore usually unsuitable for soakage. Where these materials form slopes, they often have marginal stability and adding water to these risks initiating instability in the form of shallow creep or landslides.

---

<sup>6</sup> Soakage potential maps in Geomaps are not available at the date of this document's publication.

Underlying unweathered rock also tends to have low permeability, although defects (e.g., faults) may provide zones which can transmit larger volumes of water. The location and extent of fracturing is difficult to predict from the surface and may not be intercepted in boreholes (particularly where fractures are near vertical). For this reason, sedimentary rock in Auckland is not generally targeted for soakage.

### **B 2.3 Recent sedimentary deposits**

Marine sediments and alluvium of the Tauranga Group typically have low permeability and are generally not suitable for soakage. An exception is the Papakura Peat where groundwater recharge may be required to maintain groundwater levels at pre-development elevations by discharging stormwater into the ground.

### **B 2.4 Fill**

Sometimes, man-made fill has been placed on top of the natural geology. Fill is unlikely to be suitable for soakage unless it has been specifically designed for this purpose.

### **B 2.5 Volcanic soil and rock**

Auckland's volcanism has produced lava fields, scoria cones, tuff rings and explosion craters. Deposited ash, lapilli and tuff, scoria and basalt lava partially cover many parts of the region. Volcanic soils have highly variable permeability. Scoria typically has a high permeability suitable for soakage, while tuff and ash deposits include silts and clays (with variable sand content) and often result in low permeability and so are unlikely to be suitable. However, these may contain lenses of scoria with comparatively high permeability and suitable soakage capacity. Care must be taken to check that scoria areas are large enough to handle the proposed soakage quantities, and that they do not result in springs downstream where the scoria beds meet the ground surface.

Basalt lava permeability is also highly variable but where fractured can be more suitable for soakage than volcanic soils.

Basalt is most commonly found around the Auckland City isthmus (the Auckland Volcanic Field) and Pukekohe (South Auckland Volcanic Field). The basalts have varying characteristics that result in significant variation in permeability. A soakage device that has intersected a high permeability fracture or fractured zone may have good soakage while a nearby device, possibly on a few metres distance away, may encounter solid rock or volcanic soils and have relatively poor soakage.

In locations where these basalts are overlain by soil, adequate soakage may be achieved if high permeability volcanic soils are encountered (e.g., scoria). However, often the basalt is covered by less permeable soil (e.g., alluvium or volcanic tuff) which can vary in thickness from minimal (i.e., <1 m) to >15 m thick. Low permeability clays and silts restrict rapid infiltration of water. Therefore, boreholes need to be drilled through soils to provide direct access to the fractured basalt and to dispose of the stormwater.

## B 2.6 Peat

Some areas of Auckland (e.g., Papakura) can have extensive thicknesses of peat which have a very high water content. These are prone to settlement if the groundwater level within the peat is lowered. Groundwater recharge is used in these areas to maintain the groundwater levels and reduce the potential for settlement within developed areas. Significant peat areas (>50% organic matter) occur in Takanini, Alfriston and Ardmore. Typical depth to the peat layer in these areas is 1.5 m below ground level. Smaller and more isolated peat areas are spread throughout the region but are often mixed with loam and/or clay (30-50% organic matter).

The rate at which stormwater should be discharged into peat layers is typically much lower than that of basalt, and further restricted by a high groundwater table and the need to maintain groundwater levels at set elevations.

## B 2.7 Other soakage areas

Throughout the region, there may be site-specific areas or circumstances that allow for soakage into the underlying soils, e.g., coastal settlements such as Omaha Beach depend on soakage into dunes. The suitability of soakage in such areas depends upon the permeability of the underlying soils which should be determined by a site-specific geotechnical investigation and soakage testing.

### B.3.0 Soakage testing

Soakage is the movement of water into permeable soil and rock via gravity. A soakage test gives the rate at which a known volume of water drains into the ground around a drilled hole or excavation pit. The soakage rate primarily relates to the nature of the soil layers above the water table (i.e., the unsaturated zone).

When selecting a test method and when designing, differing soil types and fracture characteristics mean that significant variations in permeability should be expected across soakage areas. Soakage tests should be located at specific location/s and depth/s of the proposed device/s to ensure the results are representative of the end product. Soakage tests should occur after all earthworks' activities.

Where multiple devices are being installed in close proximity, the testing should replicate the scenario where these devices all discharge to the ground simultaneously, creating potential interference effects, raising the groundwater more than an individual device. For most circumstances, it will be acceptable for devices more than 10 m apart to be tested independently. Devices within 10 m should have soakage testing undertaken at exactly the same time to allow potential interference effects to be reflected in the test results.

Testing should proceed in a methodical manner following the process presented in Appendix A.

## B.4.0 Factors of safety for soakage device sizing

There are many uncertainties in the design process, not least the assumed soakage rate. Soakage rates may change significantly over time and can vary by orders of magnitude. In addition, failure consequences vary depending upon the device's design and location. To account for these issues a factor of safety that reduces observed soakage rates needs to be introduced into the design process. When choosing an appropriate factor of safety, engineering judgement, depending upon the consequences of failure and subsequent design uncertainties, is needed. Key risks that are addressed with the factor of safety are:

- Insufficient confidence in input data, e.g., soakage testing
- Insufficient pre-treatment of stormwater inflow into the device
- Difficult access to the proposed device for maintenance
- Frequency of maintenance of proposed device is likely to be low.

The observed soakage rate used in the design process should be divided by the safety factor. The safety factor is generated by multiplying together two partial factors. These are:

- A factor for the consequences of failure, and
- A factor to account for uncertainty in input data.

Equation 1 should be used to calculate the required Factor of Safety ( $F_{(total)}$ ):

$$F_{(total)} = F_{(c)} \times F_{(u)} \quad \text{Equation 1}$$

Where:	$F_{(total)}$	-	Total combined Factor of Safety to be applied
	$F_{(c)}$	-	Factor of Safety representing the consequences of failure from Table 5
	$F_{(u)}$	-	Factor of Safety representing testing uncertainty from Table 6

Table 5, which has been adapted and modified from the CIRIA SuDS Manual C753 (Woods Ballard, et al., 2015), shows suggested safety factors for the consequences of failure. Note that the figures are not based on actual observation of performance loss. Table 6 shows suggested safety factors for the uncertainty in input data.

**Table 5: Suggested partial factor of safety ( $F_{(c)}$ ) for consequences of failure**

Device	Consequences of failure (see table notes for definitions of Consequence Levels)			
	Consequence Level 1	Consequence Level 2	Consequence Level 3	Consequence Level 4
Soakpit	1	1.5	2.5	5
Groundwater recharge pit	1	1	Not acceptable	Not acceptable
Rockbore	1	1.5	2.5	5



- **Consequence Level 1:** The secondary flow path complies with the Stormwater Code of Practice and all of the following apply:
  - Pre-treatment will be present
  - Access for maintenance will be easy, frequency of maintenance will be high, and a maintenance plan will be implemented.
- **Consequence Level 2:** The secondary flow path complies with the Stormwater Code of Practice and one **or** more of the following applies:
  - Pre-treatment will be present
  - Access for maintenance will be easy, frequency of maintenance will be high, and a maintenance plan will be implemented.
- **Consequence Level 3:** The secondary flow path does not meet the Stormwater Code of Practice but will only cause minor damage to external areas, or non-habitable floor flooding (e.g., surface water on car parking), and one or more of the below points applies:
  - Pre-treatment will be present
  - Access for maintenance will be easy, frequency of maintenance will be high, and a maintenance plan will be implemented.
- **Consequence Level 4:** Any other scenario, including all situations where the secondary flow path is likely to cause damage to buildings or structures, or major flooding of roads.

**Table 6: Suggested partial factor of safety ( $F_{(u)}$ ) for uncertainty in input data**

Testing situation	Testing quality (see table notes for definitions of Quality Levels)			
	Quality Level 1	Quality Level 2	Quality Level 3	Quality Level 4
Falling head test in soil	1.2	1.4	1.8	2.4
Constant head test in soil	1.0	1.2	1.5	2.0
Rockbore test	1.0	1.2	1.5	2.0

- **Quality Level 1:** All of the following apply:
  - Test undertaken at the location and depth of the proposed device
  - Test undertaken at a time when groundwater is at an annual high. For rock bores, this must be after heavy rain at a time when the rainfall-induced groundwater level peak is likely to be present
  - Groundwater monitoring with a duration of over 12 months and measurements taken in winter and summer is available within 100 m of the proposed device. For rockbore tests, this must include monitoring at short intervals (1 hour or less) to identify short-term response to heavy rainfall.

- **Quality Level 2:** All of the following apply:
  - Test undertaken at the location and depth of the proposed device
  - Test undertaken at a time when groundwater is likely to be at an annual high. For rock bores, this must be after heavy rain at a time when the rainfall-induced groundwater level peak is likely to be present.
- **Quality Level 3:** One of the following apply:
  - Test undertaken at the location and depth of the proposed device, but at a time of year when the groundwater may be lower than the seasonal high
  - Test undertaken at a time when groundwater is likely to be at an annual high, but not at the exact device location. For this to apply, the test must be in a location where the geological and hydrogeological conditions are expected to be the same as the actual proposed device location, and no more than 10 m (horizontally) and 1 m (vertically) from the actual proposed device location.
- **Quality Level 4:** Any other scenario. The designer will still have to demonstrate that the testing is representative of the proposed device location.





C



Technical  
guidance





## Section C Technical guidance

### C.1.0 Soakage into fractured rock: rockbore

#### C 1.1 Introduction

Fractures and voids in rock (mostly basalt) can act as conduits enabling stormwater to drain freely through boreholes that connect to the fractures.

Soakage into fractured rock is primarily achieved through rockbores. A rockbore device consists of a concrete manhole chamber with a concrete floor and one or more boreholes, drilled through the concrete floor and into the underlying rock aquifer. Pre-treatment is required to protect the soakage device from clogging and the aquifer from contaminants. However, where the device is only receiving water from a residential roof with a leaf trap, pre-treatment for stormwater treatment is not required. Instead, all catchment from residential roof water is to discharge to a sediment chamber/catchpit prior to eventual entry to the soakage device. Note that in this case, the sediment chamber/catchpit is considered as anti-clogging system. Water enters the rock aquifer directly through borehole/s. In some cases, the rock aquifer is covered with a topsoil layer. The borehole should penetrate the topsoil completely to allow appropriate soakage into the rock fractures.

Rockbores can be used for drainage from both private sites and discharges from public roads, i.e., drainage of roads with pre-treatment consideration.

#### **Comments:**

Soakholes with an open bottom and “hockey stick” in accordance with former guidance documents are no longer recommended for either public or private sites due to their propensity to clog the underlying fractures, high maintenance frequency and need for re-drilling.

#### C 1.2 Rockbore system components

A typical cross-section of rockbore device system components is illustrated in Figure 3. Rockbore components are presented in Table 7. Typical drawings for this device are provided in Appendix D.



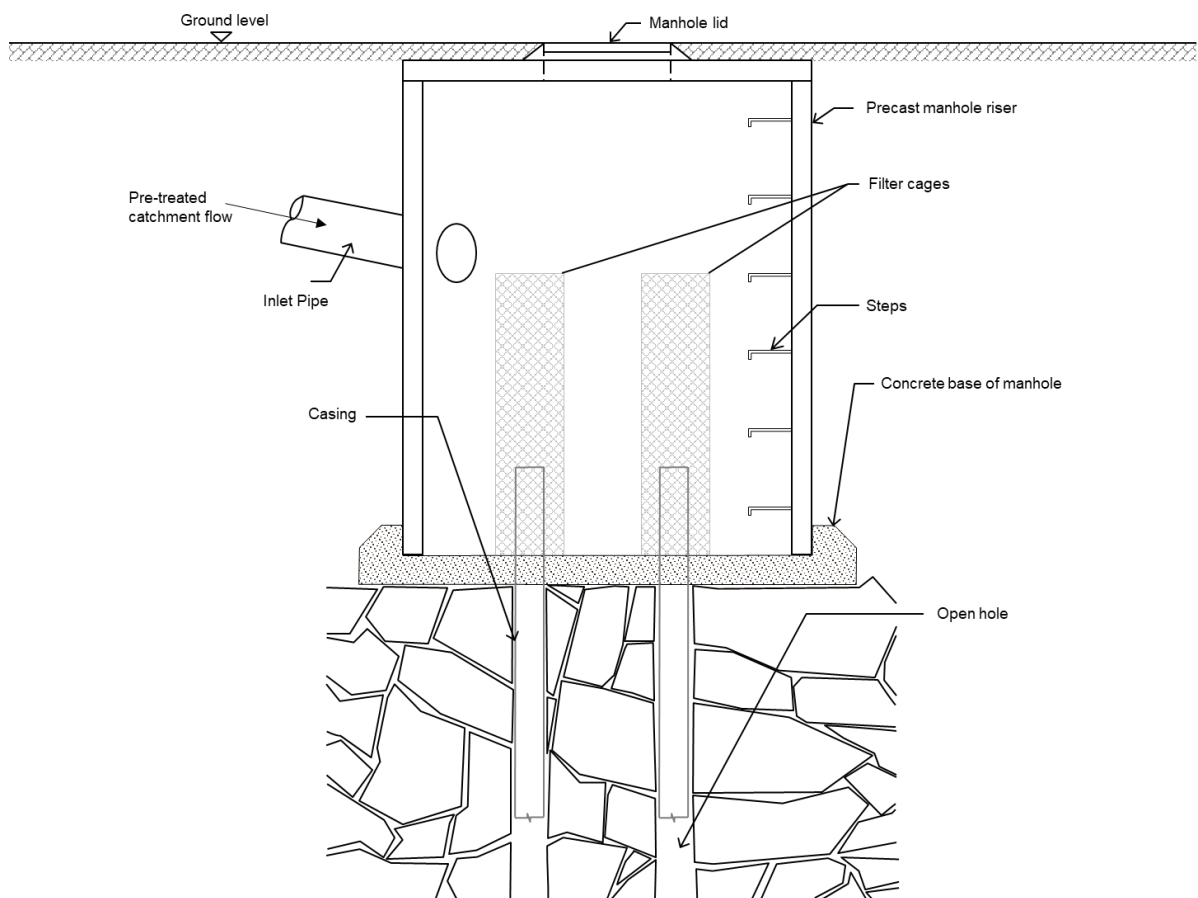

**Figure 3: Key components of rockbore devices**

**Table 7: Rockbore design components**

Component	Description
<b>Pre-treatment</b>	<ul style="list-style-type: none"> <li>• Pre-treatment of stormwater prior to entry to a soakage device is required to minimise sediment loads and prevent the device clogging.</li> <li>• Consideration needs to be given to the removal of sediment and/or contaminants before entering the soakage device and this will be primarily dependent on the catchment and its potential contaminant sources. It is the designer's responsibility to assess a pre-treatment requirement based on the likely contaminants within the catchment, e.g., sediment, gross pollutants, heavy metals from road run-off.</li> <li>• There may be additional treatment requirements as set out in the AUP for high contaminant generating areas such as high-use roads and large carparks.</li> <li>• Regular maintenance to remove particulate deposits is necessary.</li> <li>• A pre-treatment design must allow for maintenance (access for sediment removal).</li> <li>• Pre-treatment should be designed to accept runoff from all impervious areas, remove solids &gt;0.5 mm in size and be designed for easy access and maintenance.</li> <li>• Refer to Section B.1.5.1 for pre-treatment options.</li> <li>• Additional treatment devices designed in accordance with GD01 to remove stormwater contaminants may be required to meet the AUP requirements.</li> </ul>

Component	Description
<b>Inlet pipes</b>	<ul style="list-style-type: none"> <li>• Inlet pipes into the manhole chamber should be placed clear from filter cages.</li> <li>• Minimum cover is 375 mm for private drainage according to the Building Code.</li> <li>• For public systems, including road drainage, inlet pipes shall comply with SW Code of Practice and Auckland Transport standards.</li> <li>• Minimum diameter is 100 mm.</li> </ul>
<b>Manhole</b>	<ul style="list-style-type: none"> <li>• Rockbore devices consist of a precast chamber with boreholes drilled through the concrete on the bottom of the chamber.</li> <li>• Dead storage (minimum 300 mm) is provided at the base of the chamber to allow for sediment accumulation. The chamber also allows for easy access for maintenance.</li> <li>• The minimum manhole diameter is 1200 mm.</li> <li>• Minimum depth of the chamber for a new soakhole is 1.5 m. Discussion with Auckland Council is required for chambers in new bores shallower than 1.5 m, as accessibility for maintenance becomes an issue.</li> <li>• Manhole design shall comply with all SWCoP requirements.</li> <li>• Manholes deeper than 4.0 m need specific design, including health and safety considerations. Deep manholes are not preferred options due to operation and maintenance difficulties. They may be used in certain circumstances, subject to the approval of Auckland Council.</li> <li>• Manholes are not considered as providing storage or detention for the rockbore device.</li> </ul>
<b>Concrete base of the manhole</b>	<ul style="list-style-type: none"> <li>• A concrete base should be constructed at the bottom of the chamber to allow sediment to settle and be cleaned out and restrict sediment from entering the fractures and cavities in the rock surrounding the bore, causing them to clog.</li> </ul>
<b>Bores</b>	<ul style="list-style-type: none"> <li>• The borehole should be drilled into the fractured rock to strike sufficient fractures and voids.</li> <li>• The recommended maximum depth of boreholes is 20 m as maintenance is difficult at deeper depths.</li> <li>• One, two or three 150 Ø mm boreholes per chamber are drilled into fractured rock to deliver water to the underlying aquifer.</li> <li>• The minimum depth of borehole is 2.0 m.</li> <li>• Include allowance for an additional borehole that may be commissioned at a later date, to allow for redundancy or flow increase.</li> <li>• Bores positioned within 10 m of each other should be tested simultaneously to ensure that the effect of interference is accounted for.</li> </ul>
<b>Filter cages</b>	<ul style="list-style-type: none"> <li>• Each borehole should be covered with a filter cage to avoid larger particles entering and blocking the borehole.</li> <li>• 400 Ø mm filter cages are placed over each bore in the manhole to filter out gross pollutants in the stormwater and avoid blockage of the bores. The minimum height of cages is 1200 mm (refer to Appendix D for more details).</li> <li>• For retrofit of existing rockbores, the cage height should be 1 m shorter than the manhole depth.</li> <li>• A metal sleeve should be fitted around the lower 400 mm of the cage to allow for settlement of sediments at the bottom of the manhole.</li> <li>• Filter cages do not constitute a pre-treatment structure.</li> </ul>

Component	Description
<b>Step rungs</b>	<ul style="list-style-type: none"> <li>Step rungs should be placed on the side of the manhole to allow for safe access for maintenance and inspections of manhole and bores. Refer to Auckland Council Chapter 4 Code of Practice (Auckland Council, 2015).</li> </ul>

### C 1.3 Site considerations

Selected site considerations are presented in Table 8.

**Table 8: Rockbore site considerations**

Component	Description
<b>Catchment size and location</b>	<ul style="list-style-type: none"> <li>Rockbores: <ul style="list-style-type: none"> <li>Can be located in medium/large catchments (no more than 2 ha for a single rockbore device)</li> <li>Must accept runoff from all paved and roof areas and from pervious areas that contribute to runoff</li> <li>Shall not be located within flood plains (e.g., for 10% AEP and 1% AEP storm), where possible</li> <li>Should be positioned within the catchment so that all site runoff can drain naturally into the device/s</li> <li>Wherever possible, should not be in an overland flow path</li> <li>Should be designed to cater for design storms via infiltration only (i.e., without a storage or detention system). Percolation tests must be undertaken at the proposed location of the device.</li> </ul> </li> <li>Auckland Council's preferred option is to have no manholes (i.e., soakage device manhole access) in carriageways of public roads. Where connection to a public main located within a carriageway is the only viable option, approval from Auckland Council and Auckland Transport shall be obtained.</li> </ul>
<b>Minimum soakage rates</b>	<ul style="list-style-type: none"> <li>Soakage rates: <ul style="list-style-type: none"> <li>Must be determined by in situ testing at the device's proposed location</li> <li>&lt;1 L/min/m<sup>2</sup> must be tested by an IANZ certified laboratory</li> <li>≤0.5 L/min/m<sup>2</sup> are not appropriate for stormwater disposal.</li> </ul> </li> </ul>
<b>Slopes</b>	<ul style="list-style-type: none"> <li>Designs should be considered on a case-by-case basis by the designer and may require geotechnical investigations where stability issues or significant changes in the groundwater regime could occur.</li> <li>Devices on potentially unstable slopes, including all slopes &gt;25% (or closer than 15 m to a 15% slope) must have the design reviewed by a suitably qualified geotechnical engineer, engineering geologist or hydrogeologist to check stability and identify any risks to groundwater springs downstream.</li> </ul>
<b>Shared devices</b>	<ul style="list-style-type: none"> <li>Each property shall have its own soakage device.</li> <li>Soakage devices should not be shared between properties unless a legal body corporate is established to take responsibility for maintenance.</li> </ul>

Component	Description
<b>Setback</b>	<ul style="list-style-type: none"> <li>• Buildings and property boundaries: <ul style="list-style-type: none"> <li>○ A setback distance of 3 m is recommended for buildings and property boundaries. Specific geotechnical design will be required where the device may affect adjacent structures (subject to Auckland Council approval)</li> <li>○ Where this is not practically possible, a site-specific geotechnical design must be completed, taking into account the effects of the soakage device on building foundations and potential for flooding neighbouring properties. This must be done by a chartered geotechnical engineer or a professional engineering geologist</li> <li>○ Devices should not be below buildings.</li> </ul> </li> <li>• Retaining walls: <ul style="list-style-type: none"> <li>○ For walls &lt;2 m high, the setback must not be less than the height of the retaining wall + 1.5 m and where the soakage device is up slope of the wall, then the wall must have been designed to take full water loading</li> <li>○ The rock bore must be designed to discharge in a zone that is below the toe of any wall within 10 m</li> <li>○ For walls &gt;2 m high, a site-specific design must be carried out by a geotechnical engineer, considering relevant geotechnical issues and cut-off drainage of the retaining wall.</li> </ul> </li> <li>• Underground infrastructure: <ul style="list-style-type: none"> <li>○ A setback distance of 2 m from any existing infrastructure, e.g., water and wastewater pipes, is required.</li> </ul> </li> </ul>

## C 1.4 Rockbore device design

### C.1.4.1 Design considerations

Table 9 provides selected design considerations for rockbore devices.

**Table 9: Rockbore design considerations**

Component	Description
<b>Design storm</b>	<ul style="list-style-type: none"> <li>• Soakage devices shall be designed to cater for at least the flows generated by the design standard for primary systems. Key requirements for the primary system are: <ul style="list-style-type: none"> <li>○ A primary system shall be designed to accommodate the 10% AEP design storm event, adjusted for climate change</li> <li>○ Secondary flow path considerations are required when using a soakage device as a primary stormwater system. Secondary systems for stormwater shall be designed to accommodate the 1% AEP design storm event</li> <li>○ All designs shall meet the requirements of the SWCoP.</li> </ul> </li> <li>• Other design storms may be considered on a case-by-case basis (not included in this guideline).</li> </ul>

Component	Description
<b>Maintenance access</b>	<ul style="list-style-type: none"> <li>Soakage devices and associated pre-treatment components must be located where they are easily accessible for ongoing maintenance.</li> </ul>
<b>Factors of safety</b>	<ul style="list-style-type: none"> <li>The soakage rate used in rockbore design should include factors of safety outlined in Section B.4.0.</li> </ul>

## C 1.5 Device sizing

### Step 1: Site assessment

It is necessary to undertake a site assessment to choose the device's location. Some considerations are:

- Feasible manhole locations and sizes
- Number of boreholes required to achieve the required soakage rates
- Existing underground services
- Access for maintenance
- Availability of public stormwater networks.

### Step 2: Hydrological requirements

A hydrological requirement for the design shall be assessed based on Section B. The peak discharge rate  $Q_{(S)}$  for device sizing should be determined by using TP108 and SWCoP for climate change adjustment. Rockbore soakage devices shall be designed to cater for at least the flows generated by the design standard for primary systems (design storm of at least 10% AEP, adjusted for climate change).

### Step 3: Soakage rate

The soakage rate provided by each borehole should be tested as per Section B.3.0. The total soakage rate is calculated by summing the soakage rate of each borehole as per Equation 2. This guidance recommends that soakage rates for rockbore design are in units of L/s.

$$p_{(factored)} = p_1 + p_2 + p_3 + \dots + p_n \quad \text{Equation 2}$$

Where:	$p_{(factored)}$	-	Total soakage rate of the device with factor of safety applied (L/s)
	$p_1$	-	Soakage rate of the 1 <sup>st</sup> borehole with factor of safety applied (L/s)
	$p_n$	-	Soakage rate of the n <sup>th</sup> borehole with factor of safety applied (L/s)

Using Equation 3, ensure the total soakage rate is higher than the peak discharge rate.

$$Q_{(S)} \leq p_{(factored)} \quad \text{Equation 3}$$

Where:	$Q_{(S)}$	-	Peak discharge from the contributing catchment (L/s)
	$p_{(factored)}$	-	Total soakage rate of the device with factor of safety applied (L/s)

If the peak discharge rate is higher than the total soakage rate, more boreholes or multiple devices may be required.

**C.1.5.1 Summary of the rockbore soakage design process**

Figure 4 presents the suggested design process for rockbore soakage devices.

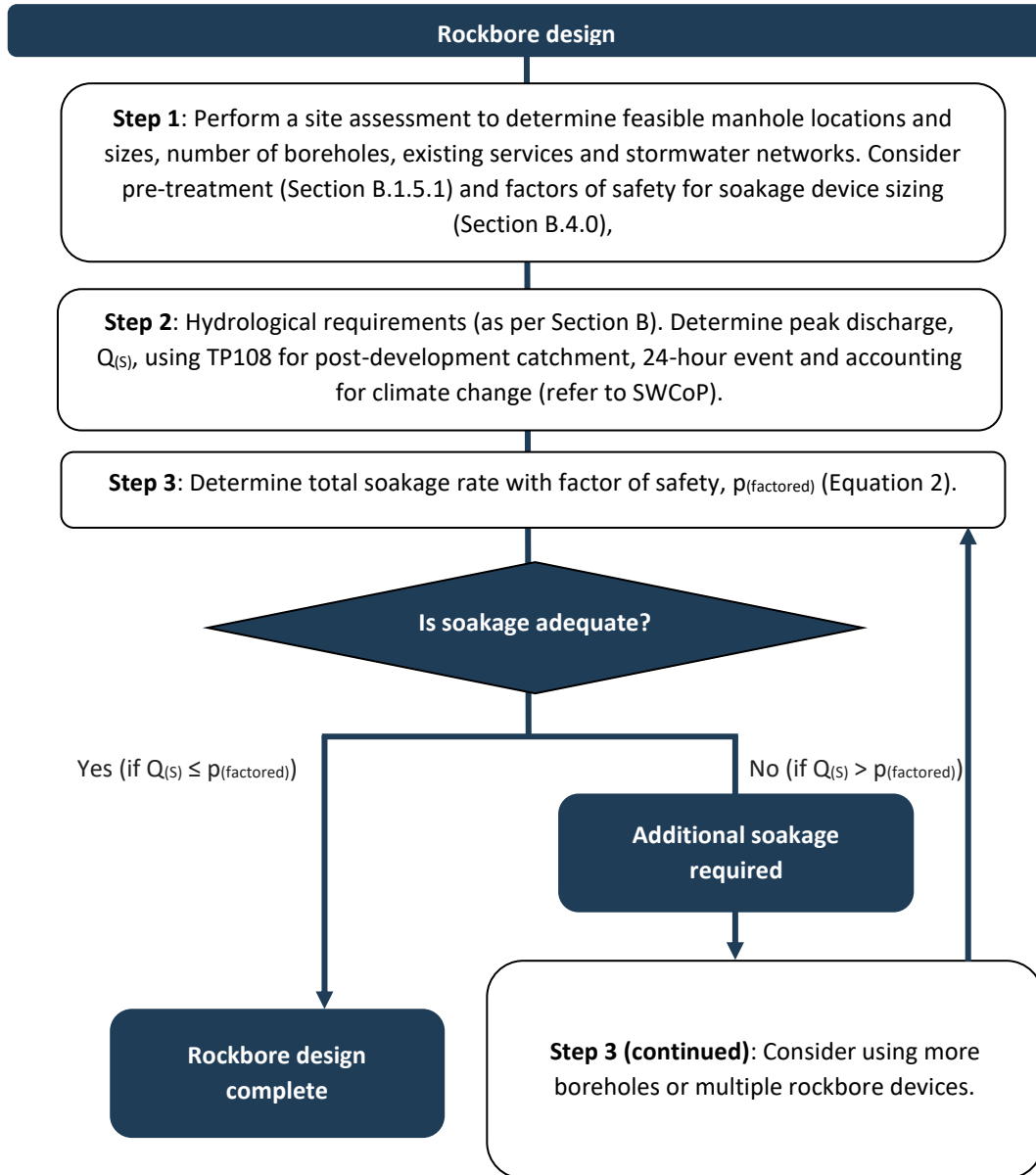

Figure 4: Rockbore design process

**C 1.6 Design example**

The site is a 1000 m<sup>2</sup> residential section in Auckland that was originally fully pervious. The proposed development has a roof area of 400 m<sup>2</sup>, a pavement area of 300 m<sup>2</sup> and a lawn area of 300 m<sup>2</sup> that must discharge runoff from the 10% AEP event, including climate change. Relevant design parameters are summarised below.

**Table 10: Parameters for rockbore design example**

Item	Value	Item	Value
Land use category	Residential	Soil group	C (CN = 74)
Design event	10% AEP, 24-hour event + climate change	Total catchment area	1000 m <sup>2</sup>
		Impervious	700 m <sup>2</sup>
		Pervious	300 m <sup>2</sup>
Rainfall	10% AEP: 130 mm over 24 hours	Catchment length	50 m
Seasonal high groundwater level	3 m below ground surface	Contaminated land	No

**Step 1 – Site assessment**

A site assessment determined that:

- The site has a highly fractured volcanic rock aquifer, covered with 1.5 m topsoil of clay and loam
- There is enough room to install two 1500 mm diameter rockbore chambers
- Neighbouring properties dispose of stormwater into the fractured rock
- There is no reticulated stormwater network available nearby to connect to
- There are no existing underground services within the site boundaries.

**Step 2 – Hydrological requirements**

After applying the climate change factor, it was found that the rainfall depth  $P_{24}$  was 147.2 mm over 24 hours for the 10% AEP. For a residential site of 1000 m<sup>2</sup>, it is appropriate to assume the minimum time of concentration allowed by TP108 of 10 minutes or 0.167 hours. The site is 30% pervious and 70% impervious. The weighted average curve number is:

$$(74 \times 0.3) + (98 \times 0.7) = 90.8$$

TP108 states that the Initial Abstraction  $I_a$  is 5 mm for pervious areas and 0 mm for impervious areas. The weighted average of initial abstraction is:

$$(5 \times 0.3) + (0 \times 0.7) = 1.5\text{mm}$$

The soil storage is calculated with the formula:

$$S = \left( \frac{1000}{CN} - 10 \right) \times 25.4 = \left( \frac{1000}{90.8} - 10 \right) \times 25.4 = 25.74\text{mm}$$

For hand calculations, the runoff index  $c^*$  should be calculated with the following formula given in TP108:

$$c^* = \frac{P_{24} - 2I_a}{P_{24} - 2I_a + 2S} = \frac{147.2 - 2 \times 1.5}{147.2 - 2 \times 1.5 + 2 \times 25.74} = 0.737$$



Reading off the graphical relationship between specific peak flow rate  $q^*$  and time of concentration  $t_c$  provided in TP108 for the curve at the required  $c^*$  gives a specific peak flow rate of  $0.158 \text{ m}^3/\text{s}$ . The catchment area  $A$  is known to be  $1000 \text{ m}^2$ . The specific peak flow rate is converted into peak runoff  $q_P$  using the following formula with  $A$  in  $\text{km}^2$ :

$$q_P = q^* AP_{24} = 0.158 \times 0.001 \times 147.2 = 23 \text{ L/s}$$

Therefore, using TP108 for the 10% AEP, 24-hour event and accounting for climate change, the peak discharge rate  $Q_{(S)}$  is  $23 \text{ L/s}$ .

### **Step 3 – Soakage rate**

The borehole diameters are  $150 \text{ mm}$  and constant head percolation tests are performed simultaneously. The results for factored soakage rate are presented below:

- Soakage rate of borehole 1:  $p_1 = 5.5 \text{ L/s}$
- Soakage rate of borehole 2:  $p_2 = 7.0 \text{ L/s}$
- Soakage rate of borehole 3:  $p_3 = 7.5 \text{ L/s}$
- Soakage rate of borehole 4:  $p_4 = 6.0 \text{ L/s}$

The total soakage rate is found using Equation 2:

$$p_{(factored)} = p_1 + p_2 + p_3 + \dots + p_n$$

$$p_{(factored)} = 5.5 + 7.0 + 7.5 + 6.0 = 26 \text{ L/s}$$

$$Q_{(S)} \leq p_{(factored)}; 23 \text{ L/s} \leq 26 \text{ L/s}$$

There is no requirement for additional storage ( $Q_{(S)} \leq p_{(factored)}$ ). Therefore, the device size is suitable, and the design is complete. The final design consists of two  $1500 \text{ mm}$  diameter manhole chambers with two  $150 \text{ mm}$  diameter bores each. Each manhole leaves space for a third bore, which may be needed for future development.

## C.2.0 Soakage into permeable soil: stormwater soakpit

### C 2.1 Introduction

Stormwater soakpits are generally used in permeable soil, e.g., volcanic soils with scoria lenses or similar permeable layers on top of fractured rock. Soakage can sometimes also be viable in dune areas.

There is a wide variety of soakage devices available. This section focuses only on stormwater soakpits.

A stormwater soakpit is an on-site stormwater system that is designed to cater for design storms through infiltration. This system is based on the principle of collecting stormwater runoff in coarse granular material to provide temporary storage while also allowing stormwater to percolate into the surrounding soil at a rate limited by the soil's infiltration capacity. If the infiltration rate and device storage capacity are not sufficient to cater for the total design storm volume, additional storage volume may be used to achieve the hydrological requirements. Pre-treatment is required to protect the soakage device from clogging and the aquifer from contaminants. However, where the device is only receiving water from a residential roof with a leaf trap, pre-treatment for stormwater treatment is not required. Instead, all catchment from residential roof water is to discharge to a sediment chamber/catchpit prior to eventual entry to the soakage device. Note that in this case, the sediment chamber/catchpit is considered as anti-clogging system.

There are many different options for providing additional storage volume in a soakpit device within, above or below the aggregate. They include storage chambers such as crates, arches, pipes, and precast concrete manholes. This section provides further guidance on additional storage via a concrete manhole, which is one of many options. It is up to the designer to design suitable storage where required. This section describes two approaches for stormwater soakpit design:

- **Stormwater soakpit:** The system has a drainage aggregate layer to store and drain stormwater into the ground. Used for smaller catchments and/or areas with higher infiltration rate
- **Stormwater soakpit with additional storage:** The system with an additional storage component (e.g., empty precast concrete manhole) to achieve hydrological requirements by detention. Used for larger catchments and/or areas with lower infiltration rate.

The largest contributing catchment for each soakpit should be 1000 m<sup>2</sup>. For catchment sizes greater than 1000 m<sup>2</sup>, multiple soakpits should be used, if possible. Otherwise, refer to GD01 for storage requirements via detention and retention. Pre-treatment is usually required to avoid clogging the device. However, where the device is only receiving water from a residential roof with a leaf trap, pre-treatment is not required. Instead, all catchment from residential roof water is to discharge to a sediment chamber/catchpit prior to eventual entry to the soakage device. Note that in this case, the sediment chamber/catchpit is not considered to be pre-treatment.

Comments:

- **Onehunga soakhole:** A legacy device included in TR40. It is a central brick or concrete chamber with scoria backfill (or equivalent drainage material) around the circumference. The central chamber is constructed with an overflow into a scoria filled pit or trench to provide the storage volume and soakage surface area from where the water can enter the surrounding soils. **This device is not recommended by Auckland Council.** The standard stormwater soakpit described in Section C.2.0 provides a similar function to the legacy Onehunga soakhole.

- Nominal soakpit:** Another legacy device included in TR40. According to TR40, if the developed impervious area is less than 20 m<sup>2</sup> (e.g., a garden shed), a nominal soakpit design may be allowed by Auckland Council. The nominal soakpit is a smaller version of the standard stormwater soakpit. Its design does not require infiltration tests to be carried out. **This device is not recommended by Auckland Council.** A standard stormwater soakpit sized using the method described in Section C 2.5 is more adequately sized and cost-effective than using a nominal soakpit.

## C 2.2 Stormwater soakpit system components

A typical cross-section illustrating stormwater soakpit system components is provided in Figure 5. Stormwater soakpit components are described in Table 11. Typical drawings for the device are provided in Appendix D.

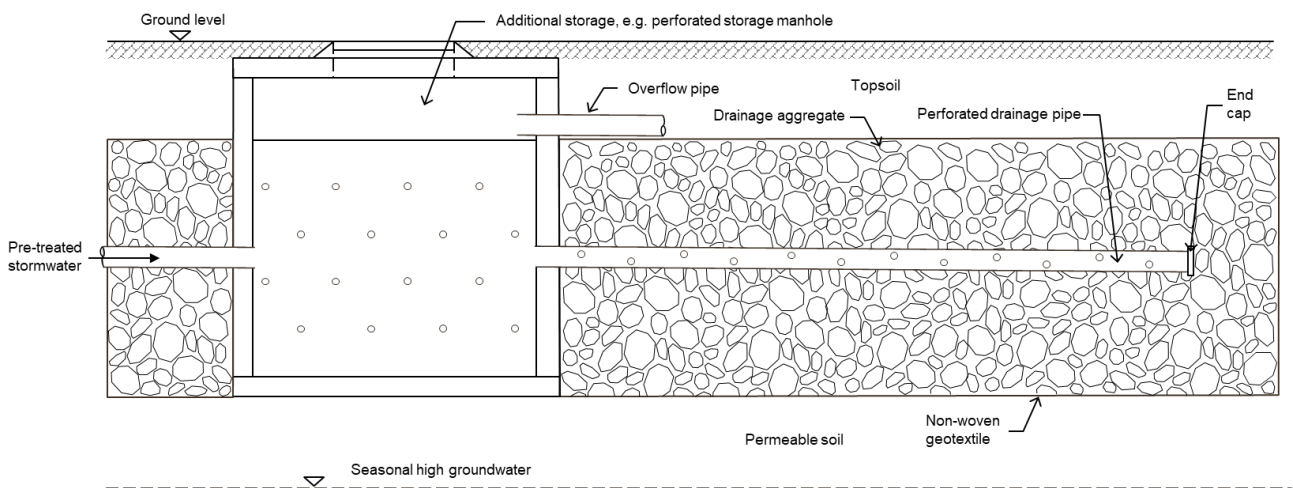

Figure 5: Stormwater soakpit components

Table 11: Stormwater soakpit design components

Component	Description
<b>Pre-treatment</b>	<ul style="list-style-type: none"> <li>• Pre-treatment of stormwater prior to entry to a soakage device is usually required to minimise sediment loads and prevent the device clogging. The exception is for residential roof-only sources with a leaf trap.</li> <li>• Consideration needs to be given to the removal of sediment and/or contaminants before entering the soakage device and this will primarily be dependent on the catchment and its potential contaminant sources.</li> <li>• Regular maintenance to remove particulate deposits is necessary. Maintenance instructions should be prepared and made available to the future owner.</li> <li>• Refer to Section B.1.5.1 for pre-treatment options.</li> <li>• An additional treatment device designed in accordance with GD01 to remove stormwater contaminants may be required to meet AUP requirements.</li> <li>• Pre-treatment design must allow for maintenance (access for sediment / contaminant / gross pollutant removal).</li> </ul>
<b>Inlet pipes</b>	<ul style="list-style-type: none"> <li>• Minimum cover is 375 mm for private drainage according to the Building Code, Section E1.</li> <li>• For public systems, including road drainage, inlet pipes shall comply with SW Code of Practice and Auckland Transport standards.</li> <li>• Minimum diameter is 100 mm.</li> </ul>
<b>Overflow pipe</b>	<ul style="list-style-type: none"> <li>• An overflow into an approved private/public reticulated system or approved outlet is required.</li> </ul>
<b>Soakpit</b>	<ul style="list-style-type: none"> <li>• Refer to Section C2.7 for aggregate specifications. Alternatives such as plastic void formers may also be used for this layer.</li> <li>• Minimum 300 mm cover with re-laid topsoil.</li> <li>• If plastic void formers are used, loading and cover requirements must be checked to ensure they are fit for the proposed use.</li> <li>• The thickness of the drainage aggregate pit surrounding the central chamber should be determined based on the required storage volume and surface area. The maximum depth is 1500 mm below ground level. Deeper layers need specific design and are subject to Auckland Council approval.</li> </ul>
<b>Geotextile</b>	<ul style="list-style-type: none"> <li>• Soakpit systems should be wrapped with geotextile (sides, base and top of the system) to prevent the migration of in situ soil particles into the drainage media material.</li> <li>• Refer to Section B2.5 for further specifications.</li> </ul>

Component	Description
<b>Additional storage (optional)</b>	<ul style="list-style-type: none"> <li>• There are many different options to provide a storage volume, e.g., crates, arches, pipes, and precast concrete manholes that could be placed within, above or below of aggregate.</li> <li>• Additional storage manholes are not the preferred option in private property due to operation and maintenance requirements as well as health and safety considerations.</li> <li>• Additional storage: precast perforated concrete manhole chamber: <ul style="list-style-type: none"> <li>○ Minimum manhole diameter is 1050 mm</li> <li>○ The manhole should not be deeper than the aggregate pit</li> <li>○ All manhole designs shall comply with SWCoP requirements</li> <li>○ It shall be extended to the surface with a cast-iron lid to allow access</li> <li>○ Ø20 mm holes are drilled at 300 mm horizontal and 150 mm vertical spacing into the central chamber to allow water to infiltrate into the surrounding drainage media layer</li> <li>○ Step rungs should be placed on the side of the manhole to allow for safe access for maintenance and inspections of manhole and boreholes. Refer to Auckland Council Chapter 4 Code of Practice (Auckland Council, 2015)</li> <li>○ A storage manhole does not constitute a pre-treatment structure</li> <li>○ Auckland Council's preferred option is to have no manholes in public road carriageways. Where a connection to a public main located within a carriageway is the only viable option, approval from Auckland Council and Auckland Transport shall be obtained</li> <li>○ Manholes deeper than 4.0 m need specific design, including health and safety considerations. Deep manholes are not preferred options due to operation and maintenance difficulties. They may be used in certain circumstances, subject to the approval of Auckland Council.</li> </ul> </li> </ul>
<b>Drainage pipe</b>	<ul style="list-style-type: none"> <li>• The drainage pipe shall be perforated to allow water to discharge into the drainage media layer with a minimum depth of 300 mm drainage aggregate underneath the pipe.</li> <li>• The drainage pipe must be accessible for maintenance (e.g., water jet) and CCTV inspection.</li> </ul>
<b>Observation well</b>	<ul style="list-style-type: none"> <li>• An observation well should be installed so that future inspections can determine whether the device is functioning as designed.</li> <li>• It should include a perforated PVC pipe of 100-200 mm diameter and a cap.</li> </ul>

### C 2.3 Site considerations

Selected site considerations are presented in Table 12.

**Table 12: Stormwater soakpit site considerations**

Component	Description
<b>Catchment size and location</b>	<ul style="list-style-type: none"> <li>• Stormwater soakpits:               <ul style="list-style-type: none"> <li>○ Should be located in small catchments (no more than 1000 m<sup>2</sup> for a single device)</li> <li>○ Must accept runoff from impervious areas (e.g., paved and roof areas) and pervious areas (e.g., grassed areas) that contribute to runoff</li> <li>○ Shall not be located within 10% AEP storm flood plains and should be outside of the 1% AEP, where possible</li> <li>○ Should be positioned within the catchment so that all site runoff can drain naturally into the device/s.</li> <li>○ Should not be in an overland flow path, wherever possible.</li> </ul> </li> <li>• Percolation tests must be undertaken at the proposed location and depth of the device.</li> </ul>
<b>Groundwater</b>	<ul style="list-style-type: none"> <li>• The invert of the soakage device should be:               <ul style="list-style-type: none"> <li>○ At least 500 mm above the seasonal high groundwater level (where this has been monitored over a full winter-spring season with a piezometer or similar to give a reasonable measurement of the seasonal high level), or</li> <li>○ 1 m above the seasonal high groundwater level where this monitoring has not been undertaken.</li> </ul> </li> </ul>
<b>Minimum soakage rates</b>	<ul style="list-style-type: none"> <li>• Soakage rates:               <ul style="list-style-type: none"> <li>○ Must be determined by in situ testing at the device's proposed location</li> <li>○ &lt;1 L/min/m<sup>2</sup> must be tested by an IANZ certified laboratory</li> <li>○ ≤0.5 L/min/m<sup>2</sup> are not appropriate for stormwater disposal.</li> </ul> </li> </ul>
<b>Slopes</b>	<ul style="list-style-type: none"> <li>• Devices:               <ul style="list-style-type: none"> <li>○ Should not be located on unstable slopes</li> <li>○ Placed on a slope &gt;25% (14°) will require specific design by a Chartered Geotechnical Engineer or Professional Engineering Geologist</li> <li>○ Those without a specific geotechnical design must be placed more than 15 m away from slopes &gt;15% (8°)</li> <li>○ Where on slopes &lt;25% but closer than 15 m to a 15% slope, must have the design reviewed by a suitably qualified geotechnical engineer or engineering geologist</li> <li>○ Should be considered on a case-by-case basis by the designer and may require geotechnical investigations where stability issues or significant changes in the groundwater regime could occur.</li> </ul> </li> <li>• Particular care is needed when designing devices up-slope of a cutting. Any devices within 20 m of a cutting require specific design by a Chartered Geotechnical Engineer or Professional Engineering Geologist.</li> </ul>

Component	Description
<b>Shared devices</b>	<ul style="list-style-type: none"> <li>• Wherever possible each property shall have its own soakage device.</li> <li>• Soakage devices should not be shared between properties unless a legal body corporate is established to take responsibility for maintenance.</li> </ul>
<b>Setback</b>	<ul style="list-style-type: none"> <li>• Buildings and property boundaries: <ul style="list-style-type: none"> <li>○ A setback distance of 3 m is recommended for buildings and property boundaries. Specific geotechnical design will be required where the device may affect adjacent structures (subject to Auckland Council approval)</li> <li>○ Where this is not practically possible, a site-specific geotechnical design must be completed taking into account the effects of the soakage device on building foundations and potential for flooding neighbouring properties. This must be done by a chartered geotechnical engineer or a professional engineering geologist</li> <li>○ Devices should not be below buildings.</li> </ul> </li> <li>• Retaining walls: <ul style="list-style-type: none"> <li>○ For walls &lt;2 m high: <ul style="list-style-type: none"> <li>○ The setback must not be less than the height of the retaining wall + 1.5 m</li> <li>○ Where the soakage device is less than 10 m up slope of the wall, then the wall must have been designed to take full water loading and the base of the soakage device should, where possible, be at an elevation below the toe of the wall.</li> </ul> </li> <li>○ For walls &gt;2 m high within 10 m of a soakage device, a site-specific design must be carried out by a geotechnical engineer, considering relevant geotechnical issues and cut-off drainage of the retaining wall.</li> </ul> </li> <li>• Underground infrastructure: <ul style="list-style-type: none"> <li>○ A setback distance of 2 m is required from any existing water and wastewater pipes.</li> </ul> </li> </ul>

## C 2.4 Proprietary soakage devices

A wide variety of proprietary systems are available using either plastic or concrete products to create underground storage basins with a large soakage surface area that allows for soakage into surrounding soils, subject to Auckland Council approval. It is the responsibility of designer/specifier and the contractor to ensure that the proprietary soakage system is fit-for-purpose and meets Auckland Council standards and requirements, including loading and cover requirements.

## C 2.5 Stormwater soakpit design

### C.2.5.1 Design considerations

Table 13 provides the selected design considerations for stormwater soakpit devices.



**Table 13: Stormwater soakpit design considerations**

Component	Description
<b>Maintenance access</b>	<ul style="list-style-type: none"> <li>Soakage devices and associated pre-treatment components must be located where they are easily accessible for ongoing maintenance.</li> <li>Soakage devices must be placed so as to ensure their effective operation.</li> </ul>
<b>Design storm</b>	<p>Soakpits shall be designed as a primary stormwater system. Key requirements for a primary system, according to SWCoP, are:</p> <ul style="list-style-type: none"> <li>Primary systems shall be designed to accommodate the 10% AEP design storm event, adjusted for climate change</li> <li>Secondary flow path considerations are required when using a soakage device as a primary stormwater system. Secondary systems for stormwater shall be designed to accommodate the 1% AEP design storm event</li> <li>All designs shall meet the requirements of the SWCoP</li> <li>Other design storms may be considered on a case-by-case basis (not included in this guideline)</li> <li>Devices could also be designed exclusively for groundwater recharge purposes.</li> </ul>
<b>Drainage time</b>	<ul style="list-style-type: none"> <li>A soakage device may provide temporary storage, but it must drain within 24 hours of the end of the rainfall event.</li> </ul>
<b>Factors of safety</b>	<ul style="list-style-type: none"> <li>The soakage rate used in stormwater soakpit design should include factors of safety outlined in Section B.4.0.</li> </ul>

## C 2.6 Device sizing

### Step 1: Site assessment

It is necessary to undertake a site assessment to choose the device location/s. Some considerations are:

- The location and dimensions of the device
- Existing underground services
- Existing public stormwater networks (if any)
- Soil infiltration rates
- Groundwater level.

It is recommended that soakage rates for soakpit design are tested in units of L/min/m<sup>2</sup>.

### Step 2 – Hydrological requirements

A hydrological requirement for the design shall be assessed based on Section B. The peak discharge rate  $Q_{(S)}$  for device sizing should be determined by using TP108. Soakpits shall be designed as a primary stormwater system. A primary stormwater system shall be designed to cater for design storms of at least 10% AEP and account for climate change.

**Step 3a – Initial soakpit design**

Soakpit design is based on two parameters: device volume and the available soakage relative to inflow. Figure 6 relates two coefficients,  $C_{(req)}$  and  $C_{(storage)}$ , which are respectively related to these two parameters. The initial soakpit size is suggested to be based on a chosen  $C_{(storage)}$  value of 0.7.

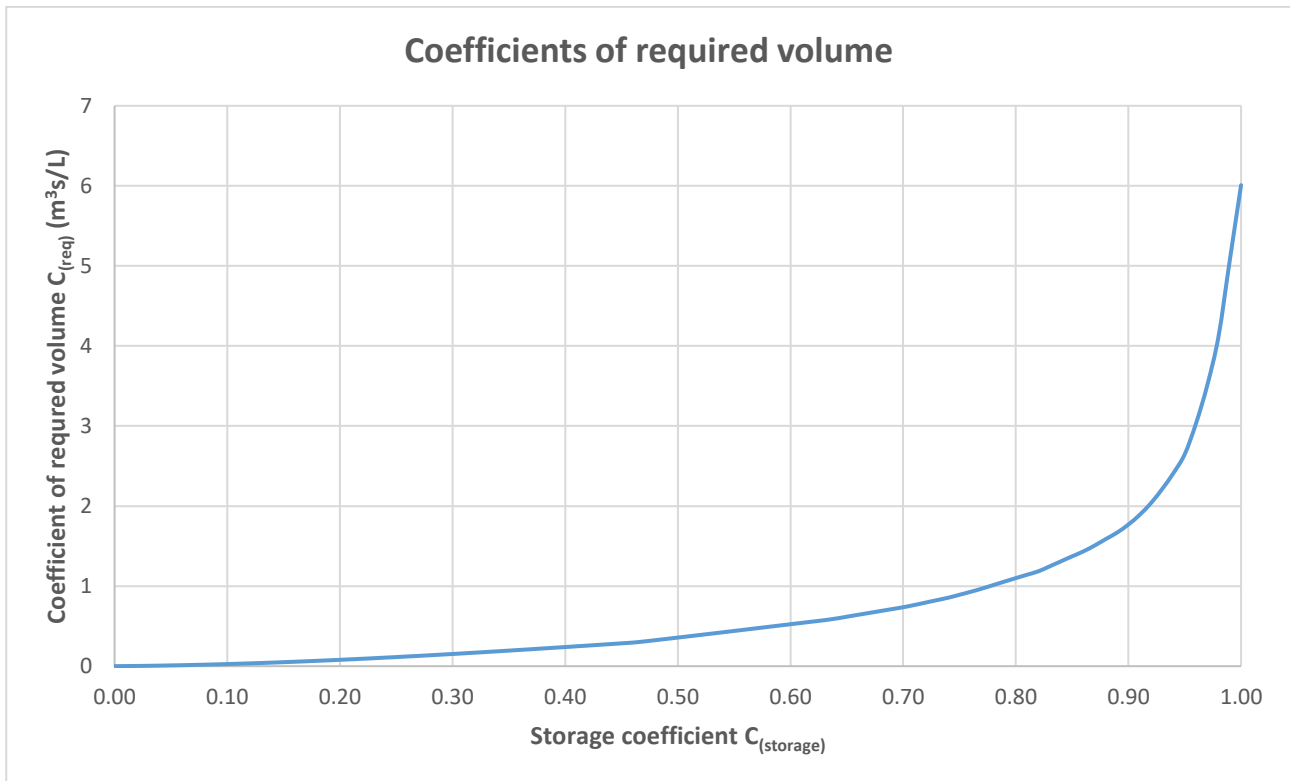

**Figure 6: Chart to determine coefficient of required volume**

Equation 4 should be used to convert the coefficient of required volume into actual required storage volume:

$$V_{(req)} = C_{(req)} \times Q_{(s)} \quad \text{Equation 4}$$

Where:	$V_{(req)}$	-	Required storage volume (m³)
	$C_{(req)}$	-	Coefficient of required volume (m³s/L)
	$Q_{(s)}$	-	Peak discharge from contributing catchment (L/s)

The required surface area for soakage should be calculated using Equation 5:

$$A_{(req)} = \frac{Q_{(s)}(1 - C_{(storage)})}{P_{(factored)}} \times 60 \quad \text{Equation 5}$$

Where:	$A_{(req)}$	-	Required surface area for soakage (m²)
	$Q_{(s)}$	-	Peak discharge from contributing catchment (L/s)
	$C_{(storage)}$	-	Storage coefficient (L/s)
	$P_{(factored)}$	-	Tested soakage rate with factor of safety applied (L/min/m²)

If the given soakage rate is in units of L/s, either Worksheet 1 or Worksheet 2 in A.1.1.1.1.1 Appendix B1.0 should be used to convert the units to L/min/m<sup>2</sup>.

With the required storage volume and surface area for soakage, a choice of length, width, and depth of soakpit, along with a void space for the aggregate, should be made.

### **Step 3b: Adjustment of soakpit size**

The selected dimensions should result in a storage volume and soakage area larger than the required values, in accordance with Equation 6 and Equation 7:

$$V_{(soakpit)} \geq V_{(req)} \quad \text{Equation 6}$$

Where:

$V_{(soakpit)}$	-	Available storage volume in soakpit (m <sup>3</sup> )
$V_{(req)}$	-	Required storage volume (m <sup>3</sup> )

$$A_{(s)} \geq A_{(req)} \quad \text{Equation 7}$$

Where:

$A_{(s)}$	-	Available surface area for soakage (m <sup>2</sup> )
$A_{(req)}$	-	Required surface area for soakage (m <sup>2</sup> )

The actual storage volume of the soakpit should be calculated using Equation 8. Note that Equation 8 assumes that the additional storage (if any) is located inside the soakpit.

$$V_{(soakpit)} = (L_{(s)} \times W_{(s)} \times d_{(s)}) \times \phi_{(soakpit)} + V_{(add)} \times (1 - \phi_{(soakpit)}) \quad \text{Equation 8}$$

Where:

$V_{(soakpit)}$	-	Available storage volume in soakpit (m <sup>3</sup> )
$L_{(s)}$	-	Length of soakpit (m)
$W_{(s)}$	-	Width of soakpit (m)
$d_{(s)}$	-	Depth of soakpit (m)
$\phi_{(soakpit)}$	-	Porosity or void space in soakpit (%)
$V_{(add)}$	-	Net additional storage volume, if any (m <sup>3</sup> )

The soakage area inside the soakpit should be calculated using Equation 9. The surface area available for soakage ( $A_{(s)}$ ) is assumed to be the base area of the soakpit plus half the wall area.

$$A_{(s)} = L_{(s)} \times W_{(s)} + d_{(s)} \times L_{(s)} + d_{(s)} \times W_{(s)} \quad \text{Equation 9}$$

Where:

$A_{(s)}$	-	Available surface area for soakage (m <sup>2</sup> )
$L_{(s)}$	-	Length of soakpit (m)
$W_{(s)}$	-	Width of soakpit (m)
$d_{(s)}$	-	Depth of soakpit (m)

If the provided soakage area or storage volume are insufficient, the dimensions of the soakpit should be increased until Equation 8 and Equation 9 are satisfied.

For the chosen dimensions, the device may be significantly oversized for one parameter, while just meeting the requirements of the other, or the device may have unsatisfactory proportions. It is possible that the required soakage area and storage volume are not mutually achievable without these situations occurring. In this case, the selection of the storage coefficient  $C_{(storage)}$  was not efficient. The design should be adjusted by iterating through Steps 3a and 3b with different  $C_{(storage)}$  values.

Each iteration should be completed according to the following guidelines:

- To reduce required soakage area, increase  $C_{(storage)}$
- To reduce required storage volume, decrease  $C_{(storage)}$ .

Note: The  $C_{(storage)}$  value for an efficient design may lie outside the suggested range of 0.6 to 0.9 for the initial soakpit size. Changing the required soakage area by changing  $C_{(storage)}$  will also have an effect on required storage volume and vice versa.

New soakpit dimensions should be chosen to satisfy the new  $V_{(req)}$  and  $A_{(req)}$ . An efficient soakpit design should not be significantly oversized for both storage volume and soakage area, while having satisfactory proportions.

When the soakpit size is satisfactory, the device drainage time should be checked. The soakage device must drain within 24 hours of the end of the rainfall event. The time to drain may be calculated using Equation 10 if the soakage rate was determined in units of L/min/m<sup>2</sup>:

$$T_{(drain)} = \frac{V_{(req)} \times 1000}{P_{(factored)} \times A_{(s)} \times 60} \quad \text{Equation 10}$$

Where:	$T_{(drain)}$	-	Time to drain the stored volume (hr)
	$V_{(req)}$	-	Required storage volume (m <sup>3</sup> )
	$P_{(factored)}$	-	Tested soakage rate with factor of safety applied (L/min/m <sup>2</sup> )
	$A_{(s)}$	-	Available surface area for soakage

A specific calculation is required if the soakpit shape is not rectangular.

If the time to drain is greater than 24 hours, Steps 3a and 3b should be repeated after increasing the soakpit dimensions. If the time to drain is less than 24 hours, the device design is complete.

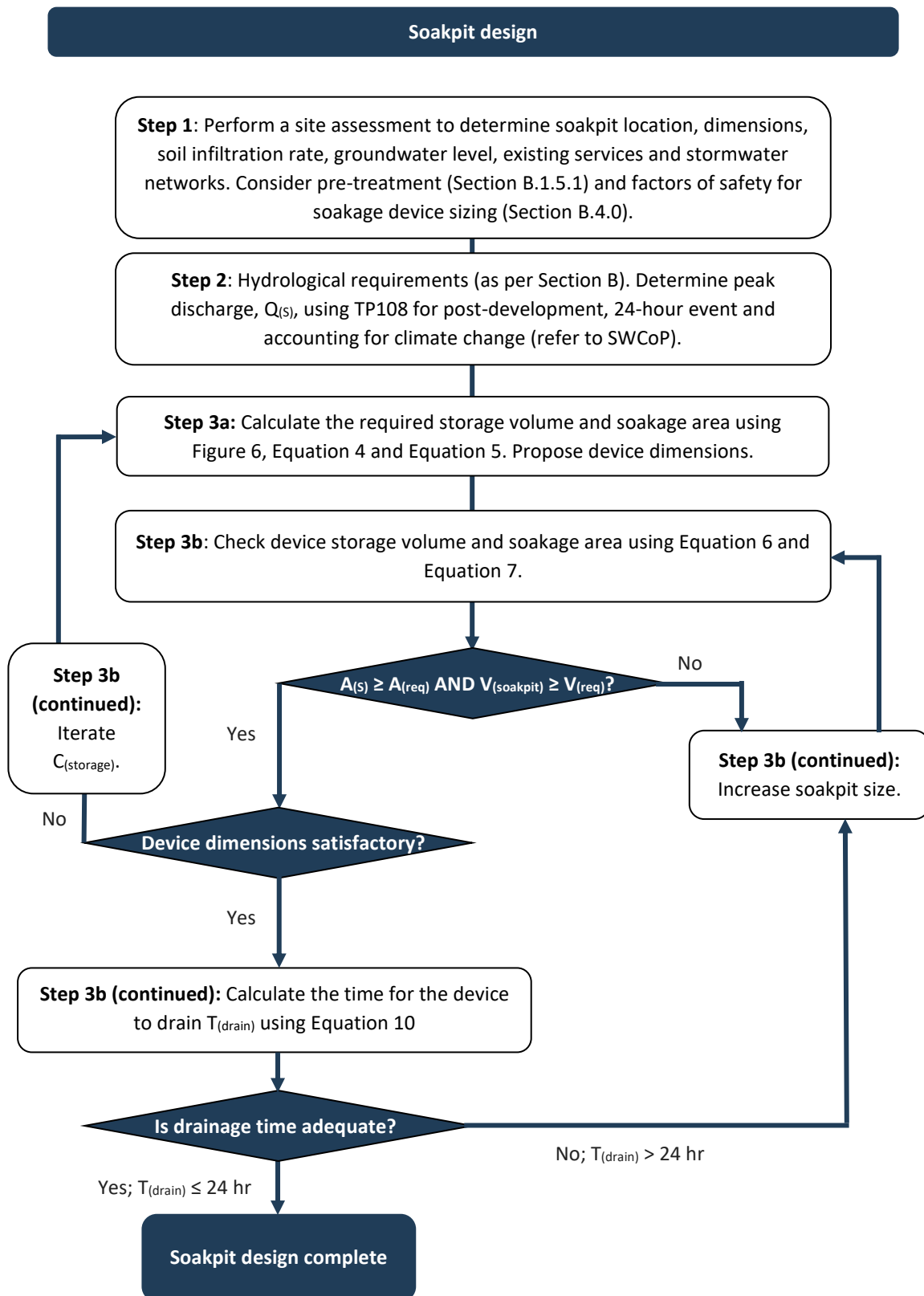

Figure 7: Soakpit design process

## C.2.7 Aggregate specification for soakpits

Drainage aggregate media should comply with all requirements for soakage pit aggregate in Auckland Council's Earthworks Specification ACS510<sup>7</sup>. The key elements of this specification are summarised in the sections below.

### C.2.7.1 Particle size distribution

The particle size distribution of the aggregate should conform to the envelope limits defined in Table 14, when the aggregate is tested according to Standards New Zealand *Methods of Sampling; Testing Road Aggregates* (NZS 4407:2015); and Test 3.8.1 (Wet Sieving Test).

**Table 14: Required particle size distribution for drainage pit aggregate**

Sieve aperture (mm)	Upper limit % passing	Lower limit % passing
40.0 mm or 37.5 mm	100	N/A
2.36 mm	N/A	10
0.60 mm	N/A	1

### C.2.7.2 Particle size uniformity

The  $D_{90} / D_{10}$  ratio shall not be higher than 10 when the aggregate is tested according to Standards New Zealand *Methods of Sampling; Testing Road Aggregates* NZS 4407:2015; and Test 3.8.1 (Wet Sieving Test).

### C.2.7.3 Ground preparation

Subgrade preparation for soakage devices requires the removal of sharp rocks, roots and other items that could penetrate the geotextile. The finished surface should be lightly scarified to remove any smeared surfaces that may reduce permeability.

### C.2.7.4 Geotextile

Granular fill placed to form the detention portion of a soakage device or soakpit shall be placed on a geotextile liner separating the aggregate from the surrounding soil. The geotextile should wrap the soakage device and reduce migration of native soil particles into the soakage media while allowing stormwater to pass into the surrounding soils. The geotextile shall be a lightweight, non-woven, with minimum Class C strength and Class 1 filtration capacity (based on Transit New Zealand F/7: 2003 *Specification for Geotextiles* and the Transit New Zealand F/7 *Notes to the Specification for Geotextiles*). All overlaps should meet minimum requirements specified by geotextile supplier, but not less than 300 mm.

<sup>7</sup> This document can be found in [www.aucklanddesignmanual.co.nz](http://www.aucklanddesignmanual.co.nz). This specification is not available at the date of this document's publication.

### C.2.7.5 Placement and compaction

Compaction shall generally be achieved by tamping with the bucket of an excavator. This maximises the available void spaces. Because of the limited compaction, and also because of the risk of softening of the subgrade, it is not appropriate to build a soakpit adjacent to a foundation or under a structure or pavement using this specification.

If the device is to be placed adjacent to a foundation, or under a pavement, site-specific geotechnical design will be required. The designer will need to demonstrate that the aggregate can provide the required strength and stiffness for the intended use, as well as adequate void space for the storage of stormwater.

## C 2.8 Design example

The site is a residential section with 300 m<sup>2</sup> of impervious area and 20 m<sup>2</sup> of pervious area. A soakpit is required to dispose of 10% AEP runoff. Design parameters are given below:

**Table 15: Parameters for soakpit design example**

Item	Value	Item	Value
Land use category	Residential	Site slope	5%
Catchment area	320 m <sup>2</sup>	Rainfall depth	130 mm + climate change
Impervious	300 m <sup>2</sup>	Factored site soil infiltration rate	3 L/min/m <sup>2</sup>
Pervious	20 m <sup>2</sup>	Aggregate porosity	30%
Seasonal high groundwater level	3 m below ground surface		
Contaminated land	No		

### Step 1 – Site assessment

A site assessment found that:

- The soil infiltration rate is 3 L/min/m<sup>2</sup>
- The seasonal high groundwater level is 3 m below the ground surface
- There are no existing underground services within the site boundaries
- There is no reticulated stormwater network available nearby to connect to
- No contaminated land exists on the site.

The infiltration rate for this site is acceptable (Section B.3.0), provided that there is pre-treatment for sediments and retention. The chosen device is a soakpit.



### **Step 2 – Hydrological requirements**

After applying the climate change factor, it was found that the rainfall depth  $P_{24}$  was 147.2 mm over 24 hours. For a residential site of 320 m<sup>2</sup>, it is appropriate to assume the minimum time of concentration allowed by TP108 of 10 minutes or 0.167 hours. The site is 6.25% pervious and 93.75% impervious. The weighted average curve number is:

$$(74 \times 0.0625) + (98 \times 0.9375) = 96.5$$

TP108 states that the Initial Abstraction  $I_a$  is 5 mm for pervious areas and 0 for impervious areas. The weighted average of initial abstraction is:

$$(5 \times 0.0625) + (0 \times 0.9375) = 0.3\text{mm}$$

The soil storage is calculated with the formula:

$$S = \left( \frac{1000}{CN} - 10 \right) \times 25.4 = \left( \frac{1000}{96.5} - 10 \right) \times 25.4 = 9.21\text{mm}$$

For hand calculation, the runoff index  $c^*$  should be calculated with the following formula given in TP108:

$$c^* = \frac{P_{24} - 2I_a}{P_{24} - 2I_a + 2S} = \frac{147.2 - 2 \times 0.3}{147.2 - 2 \times 0.3 + 2 \times 9.21} = 0.888$$

Reading off the graphical relationship between specific peak flow rate  $q^*$  and time of concentration  $t_c$  provided in TP108 for the curve at the required  $c^*$  gives a specific peak flow rate of 0.162. The catchment area  $A$  is known to be 320 m<sup>2</sup>. The specific peak flow rate is converted into peak runoff  $q_P$  using the following formula with  $A$  in km<sup>2</sup>:

$$q_P = q^* A P_{24} = 0.162 \times 0.00032 \times 147.2 = 7.6\text{L/s}$$

Therefore, using TP108 for the 10% AEP, 24-hour event and accounting for climate change, the peak discharge rate  $Q_{(s)}$  is 7.6 L/s.

### **Step 3a – Initial soakpit design**

The guidance recommends choosing an initial  $C_{(storage)}$  between 0.6 and 0.9. For this example, the chosen initial  $C_{(storage)}$  is 0.7. Figure 6 gives a  $C_{(req)}$  value of 0.75.

Equation 4 and Equation 5 should be used to find the required storage volume and soakage area of the initial soakpit design.

$$V_{(req)} = C_{(req)} \times Q_{(s)} = 0.75 \times 7.6 = 5.7\text{ m}^3$$

$$A_{(req)} = \frac{Q_{(s)}(1 - C_{(storage)})}{P_{(total)}} \times 60 = \frac{7.6(1 - 0.7)}{3} \times 60 = 45.6\text{ m}^2$$

The required storage volume is 5.7 m<sup>3</sup> and the required soakage area is 45.6 m<sup>2</sup>. To satisfy these requirements, the chosen initial soakpit size has a length, width and depth of 8 m, 4 m, and 1.5 m respectively. The chosen aggregate porosity is 30%. No additional storage is used.

**Step 3b: Adjustment of soakpit size**

The adequacy of the chosen size should be checked using Equation 6 and Equation 7.

To use Equation 6, the storage volume of the soakpit should be calculated using Equation 8.

$$V_{(soakpit)} = (L_{(s)} \times W_{(s)} \times d_{(s)}) \times \phi_{(soakpit)} + V_{(add)} \times (1 - \phi_{(soakpit)}) = 8 \times 4 \times 1.5 \times 0.3 + 0 \times (1 - 0.3) = 14.4 \text{ m}^3$$

To use Equation 7, the soakage area inside the soakpit should be calculated using Equation 9. The surface area available for soakage ( $A_{(s)}$ ) is assumed to be the base area of the soakpit plus half the wall area.

$$A_{(s)} = L_{(s)} \times W_{(s)} + d_{(s)} \times L_{(s)} + d_{(s)} \times W_{(s)} = 8 \times 4 + 8 \times 1.5 + 1.5 \times 4 = 50 \text{ m}^2$$

In the initial design, soakage area is oversized by approximately 10%, while storage volume is oversized by over 100%. Therefore, the design needs adjustment to be more efficient. In this case, the required soakage area should be reduced to allow the use of a smaller soakpit. Therefore,  $C_{(storage)}$  is increased to 0.78.

Figure 8 shows that  $C_{(req)}$  is 1. Repeating the calculations:

$$V_{(req)} = C_{(req)} \times Q_{(s)} = 1 \times 7.6 = 7.6 \text{ m}^3$$

$$A_{(req)} = \frac{Q_{(s)}(1 - C_{(storage)})}{P_{(total)}} \times 60 = \frac{7.6(1 - 0.78)}{3} \times 60 = 33.44 \text{ m}^2$$

For these parameters, the device dimensions are amended to a length, width and depth of 6.5 m, 4 m and 1 m, respectively.

$$V_{(soakpit)} = (L_{(s)} \times W_{(s)} \times d_{(s)}) \times \phi_{(soakpit)} + V_{(add)} \times (1 - \phi_{(soakpit)}) = 6.5 \times 4 \times 1 \times 0.3 + 0 \times (1 - 0.3) = 7.8 \text{ m}^3$$

$$A_{(s)} = L_{(s)} \times W_{(s)} + d_{(s)} \times L_{(s)} + d_{(s)} \times W_{(s)} = 6.5 \times 4 + 6.5 \times 1 + 1.5 \times 4 = 36.5 \text{ m}^2$$

In this case, the storage volume and soakage area are oversized by 3% and 9% respectively. The device size is satisfactory.

Checking the device drainage time using Equation 10:

$$T_{(drain)} = \frac{V_{(req)} \times 1000}{P_{(total)} \times A_{(s)} \times 60} = \frac{7.6 \times 1000}{3 \times 36.5 \times 60} = 1.2 \text{ hours}$$

The drainage time is less than 24 hours and is adequate. The final soakpit is 6.5 m long, 4 m wide and 1 m deep.

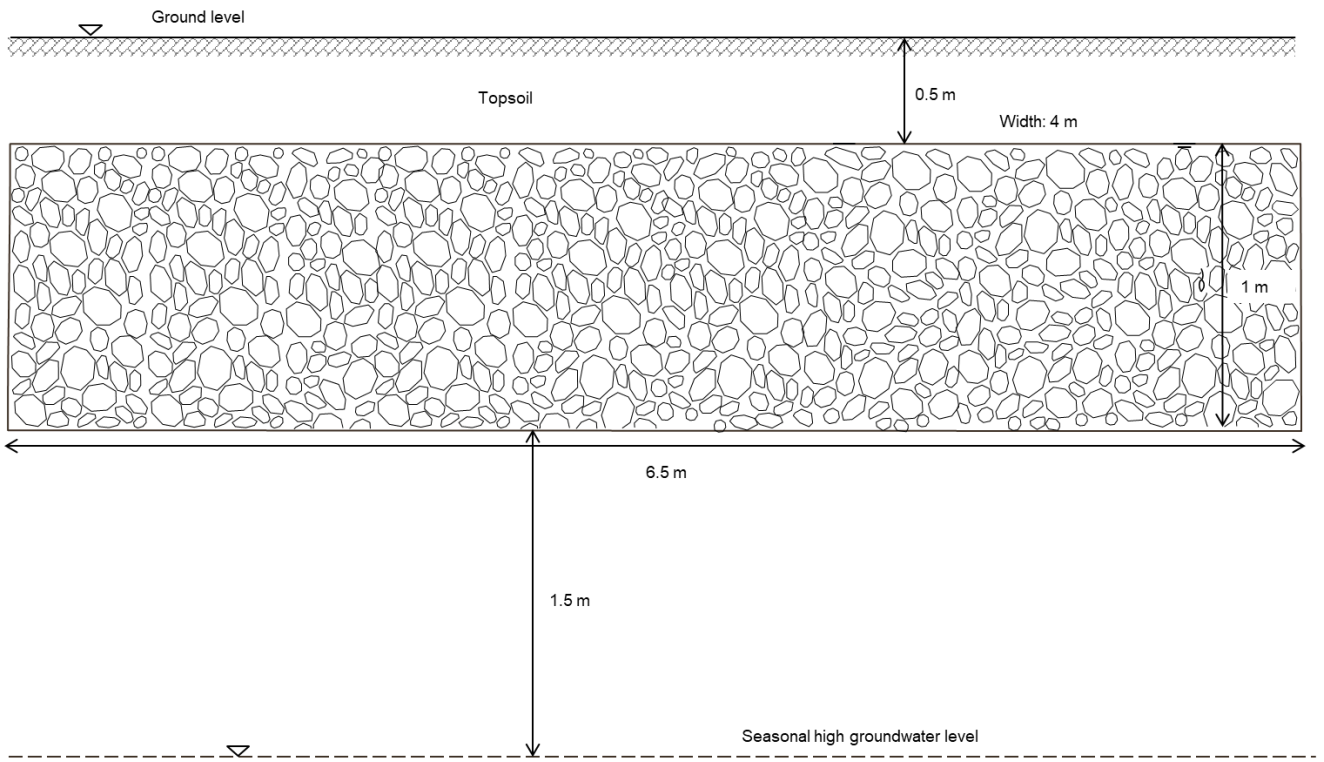

**Figure 8: Sketch of example soakpit design**  
(not to scale; some components excluded)

## C.3.0 Groundwater recharge into peat: groundwater recharge soakpit

### C 3.1 Introduction

The primary purpose of the groundwater recharge soakpit device is to avoid drawdown-induced settlement, particularly in areas with peat soil. Stormwater disposal is a secondary benefit that does not drive the design. Site-specific investigations should be carried out to determine the presence of peat and the need for a groundwater recharge device.

Groundwater recharge devices should be designed to retain the stormwater runoff from all impervious areas from the first 15 mm of runoff depth of any rainfall event (Papakura District Council, 2000). The groundwater recharge devices should be evenly distributed. Pre-treatment is required to protect the device from clogging and the aquifer from contaminants. However, where the device is only receiving water from a residential roof with a leaf trap, pre-treatment for stormwater treatment is not required. Instead, all catchment from residential roof water is to discharge to a sediment chamber/catchpit prior to eventual entry to the soakage device. Note that in this case, the sediment chamber/catchpit is considered as anti-clogging system.

### C 3.2 Groundwater recharge soakpit system components

Figure 9 illustrates a typical cross-section of a groundwater recharge soakpit system and its components. Groundwater recharge soakpit components are described in Table 16. Typical drawings for the device are provided in Appendix D.

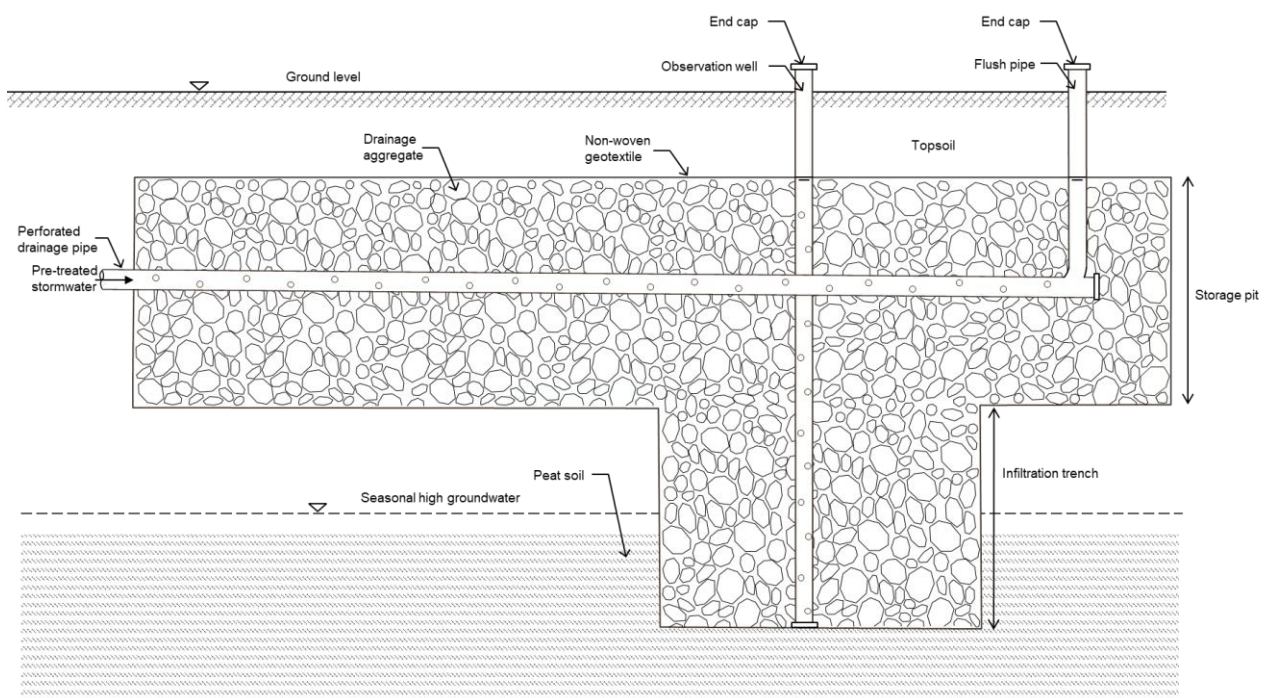

Figure 9: Example schematic of a groundwater recharge soakpit

**Table 16: Groundwater recharge soakpit design components**

Component	Description
<b>Pre-treatment</b>	<ul style="list-style-type: none"> <li>• Pre-treatment of stormwater prior to entry to a soakage device is required to minimise sediment loads and prevent the device clogging.</li> <li>• Consideration needs to be given to the removal of sediment and or contaminants before entering the soakage device, and this will primarily be dependent on the catchment and its potential contaminant sources.</li> <li>• Regular maintenance to remove particulate deposits is necessary.</li> <li>• Pre-treatment should be designed to accept runoff from all impervious areas and remove solids &gt;0.5 mm in size and be designed for easy access and maintenance.</li> <li>• Refer to Section B.1.5.1 for pre-treatment options.</li> <li>• An additional treatment device designed in accordance with GD01 to remove stormwater contaminants may be required to meet AUP requirements.</li> <li>• A pre-treatment design must allow for maintenance (access for sediment removal).</li> </ul>
<b>Inlet pipes</b>	<ul style="list-style-type: none"> <li>• Minimum cover is 375 mm for private drainage according to the Building Code.</li> <li>• For public systems, including road drainage, inlet pipes shall comply with SW Code of Practice and Auckland Transport standards.</li> <li>• Minimum diameter is 100 mm.</li> </ul>
<b>Storage pit</b>	<ul style="list-style-type: none"> <li>• Minimum 300 mm cover with re-laid topsoil. If placed under a pavement site-specific geotechnical design is required to demonstrate that the device will support the intended load.</li> <li>• Thickness of the drainage layer surrounding the central chamber should be determined based on the required storage volume and surface area. The maximum depth is 1500 mm below ground level. Specific design and health and safety considerations are required for deeper storage pits and are subject to Auckland Council approval.</li> <li>• Refer to Section C 2.7 for aggregate specification.</li> </ul>
<b>Infiltration trench</b>	<ul style="list-style-type: none"> <li>• The infiltration trench provides a direct hydraulic connection into the peat layer. A minimum of 500 mm of the trench depth should be dug into the peat layer to provide the connection. It is generally filled with the same aggregate as the storage pit.</li> <li>• The trench in the recharge pit device cuts into the underlying peat layer and should intersect with the summer groundwater table.</li> <li>• Design of the recharge pit to accommodate the 15 mm runoff depth should exclude storage in the trench.</li> <li>• The minimum trench length and depth are 1.5 m and 0.5 m respectively.</li> <li>• The minimum trench width should be 1 m.</li> </ul>
<b>Overflow pipe</b>	<ul style="list-style-type: none"> <li>• An overflow into an approved private/public reticulated system or approved outlet is required for events exceeding the first 15 mm of runoff depth.</li> </ul>
<b>Geotextile</b>	<ul style="list-style-type: none"> <li>• Groundwater recharge soakpit systems shall be wrapped with geotextile (sides, base and top of the system) to prevent the migration of in situ soil particles into the drainage media material.</li> <li>• Refer to Section B2.5 for further specifications.</li> </ul>

Component	Description
<b>Additional storage (optional)</b>	<ul style="list-style-type: none"> <li>• There are many different options to provide a storage volume within a soakpit device within, above, or below the aggregate. They include storage chambers such as crates, arches, pipes, and precast concrete manholes.</li> <li>• Where additional storage is provided by a precast perforated concrete manhole chamber: <ul style="list-style-type: none"> <li>○ Minimum manhole size is 1050 mm</li> <li>○ The manhole should not be deeper than the aggregate pit</li> <li>○ All manhole designs shall comply with SWCoP requirements</li> <li>○ Shall be extended to the surface with a cast-iron lid to allow access</li> <li>○ Ø20 mm holes are drilled at 300 mm horizontal and 150 mm vertical spacing into the central chamber to allow water to infiltrate into the surrounding drainage media layer</li> <li>○ Step rungs should be placed on the side of the manhole to allow for safe access for maintenance and inspections of manhole and bores. Refer to Auckland Council Chapter 4 Code of Practice (Auckland Council, 2015)</li> <li>○ A storage manhole does not constitute a pre-treatment structure</li> <li>○ Auckland Council's preferred option is to have no manholes in road carriageways. Where a connection to a public main located within a carriageway is the only viable option, approval from Auckland Council and Auckland Transport shall be obtained</li> <li>○ Manholes deeper than 4.0 m need a specific design, including health and safety considerations. Deep manholes are not preferred options due to operation and maintenance difficulties. They may be used in certain circumstances, subject to the approval of Auckland Council.</li> </ul> </li> </ul>
<b>Drainage pipe</b>	<ul style="list-style-type: none"> <li>• A perforated drainage pipe conveys stormwater into the storage pit.</li> <li>• The minimum bedding (above the base of the storage pit) for the drainage pipe is 300 mm.</li> <li>• The drainage pipe must be accessible for maintenance and CCTV inspection.</li> </ul>
<b>Observation well</b>	<ul style="list-style-type: none"> <li>• An observation well should be installed so that future inspections can determine whether the device is functioning as designed.</li> <li>• It works as a piezometer to monitor groundwater levels and to determine that device is functioning as designed.</li> <li>• It should include a perforated PVC pipe of 100-200 mm diameter and a cap.</li> </ul>

### C 3.3 Site considerations

Table 17 sets out the recommended site considerations for groundwater recharge soakpits. In all instances, the future asset owner must be consulted to ensure that they are aware of and are prepared to be responsible for ongoing maintenance and long-term device performance requirements.

**Table 17: Groundwater recharge soakpit site considerations**

Component	Description
<b>Catchment size and location</b>	<ul style="list-style-type: none"> <li>• Groundwater recharge soakpits:               <ul style="list-style-type: none"> <li>○ Should be located in small catchments (no more than 1000 m<sup>2</sup> for each device)</li> <li>○ Accept runoff from impervious areas only (e.g., paved and roof areas)</li> <li>○ Shall not be located within 10% AEP storm flood plains and should be outside of the 1% AEP, where possible</li> <li>○ Should be positioned within the catchment so that all site runoff can drain naturally into the device/s</li> <li>○ Should not be in an overland flow path, wherever possible.</li> </ul> </li> <li>• Percolation tests must be undertaken at the proposed location and depth of the device.</li> </ul>
<b>Groundwater</b>	<ul style="list-style-type: none"> <li>• All groundwater information (both seasonal high and low) should be gathered at the concept design stage.</li> </ul>
<b>Slopes</b>	<ul style="list-style-type: none"> <li>• In general groundwater recharge devices are only appropriate in flat, low-lying areas. If the device is to be placed on a slope, the design requirements should be re-checked to confirm that the device has been appropriately selected for the site. Devices:               <ul style="list-style-type: none"> <li>○ Should not be located on unstable slopes</li> <li>○ Those placed on a slope &gt;25% (14°) will require specific design by a Chartered Geotechnical Engineer or Professional Engineering Geologist</li> <li>○ Alternatively, devices without a specific geotechnical design must be placed more than 15 m away from slopes &gt;15% (8°)</li> <li>○ Those on slopes &lt;25% but closer than 15 m to a 15% slope, must have the design reviewed by a Chartered Geotechnical Engineer or Professional Engineering Geologist.</li> </ul> </li> <li>• Designs should be considered on a case-by-case basis by the designer and may require geotechnical investigation where stability issues or significant changes in the groundwater regime could occur.</li> </ul>
<b>Setback</b>	<ul style="list-style-type: none"> <li>• Buildings and property boundaries:               <ul style="list-style-type: none"> <li>○ A setback distance of 3 m is recommended for buildings and property boundaries. Specific geotechnical design will be required where the device may affect adjacent structures (subject to Auckland Council approval)</li> <li>○ Where this is not practically possible, a site-specific geotechnical design must be completed taking into account the effects of the soakage device on building foundations and potential for flooding neighbouring properties. This must be done by a chartered geotechnical engineer or a professional engineering geologist</li> <li>○ Devices should not be below buildings.</li> </ul> </li> <li>• Retaining walls:               <ul style="list-style-type: none"> <li>○ For walls &lt; 2 m high, the setback must not be less than the height of the retaining wall + 1.5 m and where the soakage device is up slope of the wall, then the wall must be designed to take full water loading</li> <li>○ For walls &gt; 2 m, a site-specific design must be carried out by a chartered geotechnical engineer, considering relevant geotechnical issues and cut-off drainage of the retaining wall.</li> </ul> </li> <li>• Underground infrastructure:               <ul style="list-style-type: none"> <li>○ A setback distance of 2 m is required from any existing water and wastewater pipes.</li> </ul> </li> </ul>



Component	Description
<b>Shared devices</b>	<ul style="list-style-type: none"> <li>• Wherever possible each property shall have its own groundwater recharge device.</li> <li>• Groundwater recharge devices should not be shared between properties unless a legal body corporate is established to take responsibility for maintenance.</li> </ul>

## C 3.4 Groundwater recharge soakpit design

### C.3.4.1 Design considerations

Table 18 provides selected design considerations for groundwater recharge soakpits.

**Table 18: Groundwater recharge soakpit design considerations**

Component	Description
<b>Design storm</b>	<ul style="list-style-type: none"> <li>• Shall be designed to cater for the first 15 mm of runoff depth.</li> <li>• Groundwater recharge soakpits accept runoff from impervious areas only (e.g., paved and roof areas).</li> </ul>
<b>Length-to-width ratio</b>	<ul style="list-style-type: none"> <li>• The recommended length-to-width ratio of the device is 2.5:1.</li> <li>• If site constraints mean this ratio design is not possible, the dimensions may be adjusted as necessary (refer to typical drawings in Appendix D for design limitations, e.g., maximum/minimum dimensions).</li> </ul>
<b>Overflow drainage</b>	<ul style="list-style-type: none"> <li>• All groundwater recharge devices should be designed with surface collection and conveyance drains, in case of surface blockage or rainfall events which exceed the capacity of the system.</li> </ul>
<b>Maintenance access</b>	<ul style="list-style-type: none"> <li>• Groundwater recharge devices and associated pre-treatment components must be located where they are easily accessible for ongoing maintenance.</li> <li>• Auckland Council's preferred option is to have no groundwater recharge devices in carriageways of public roads or where traffic management is required. Where a connection to a public main located within a carriageway is the only viable option, approval from Auckland Council and Auckland Transport shall be obtained.</li> </ul>
<b>Factors of safety</b>	<ul style="list-style-type: none"> <li>• The groundwater recharge or soakage rate used in groundwater recharge soakpit design should include factors of safety outlined in Section B.4.0.</li> </ul>

## C 3.5 Device sizing

### Step 1 – Site assessment

First, information should be gathered about the site and catchment. This includes undertaking a geotechnical investigation to find:

- The depth to the top of the peat layer
- The seasonal (high and low) groundwater levels
- Infiltration rate for the peat layer.

### **Step 2 – Required storage volume**

Calculate the total runoff volume ( $V_{(impervious)}$ ) from the contributing impervious areas onsite ( $A_{(impervious)}$ ), considering the first 15 mm of runoff depth. This should be done using Equation 11.  $V_{(impervious)}$  is also equal to the required storage volume of the device.

$$V_{(impervious)} = A_{(impervious)} \times 0.015 \quad \text{Equation 11}$$

Where:	$V_{(impervious)}$ -	Runoff volume from impervious area (m <sup>3</sup> )
	$A_{(impervious)}$ -	Impervious surface area (m <sup>2</sup> )

### **Step 3 – Device volume**

The required storage volume of the device  $V_{(impervious)}$  consists of two components, the volume inside the storage pit and additional storage (if any). The volume of the infiltration trench is not counted towards the device volume. The volume of the storage pit should be calculated using Equation 12. Note that Equation 12 assumes that the additional storage (if any) is located inside the storage pit. Net additional storage volume, or  $V_{(add)}$ , is the value after reductions due to solid material inside the additional storage device are applied. If no additional storage is needed,  $V_{(add)}$  is zero. If the additional storage is located outside the soakpit, a separate calculation is required.

$$V_{(storage\ pit)} = \frac{V_{(impervious)} - V_{(add)}}{\emptyset_{(storage\ pit)}} \quad \text{Equation 12}$$

Where:	$V_{(storage\ pit)}$ -	Required gross volume of storage pit (m <sup>3</sup> )
	$V_{(impervious)}$ -	Runoff volume from impervious area (m <sup>3</sup> )
	$V_{(add)}$ -	Net additional storage volume, if any (m <sup>3</sup> )
	$\emptyset_{(storage\ pit)}$ -	Porosity or void space of storage pit material (%)

Total device volume for dimensioning should be calculated using Equation 13.

$$V_{(device)} = V_{(storage\ pit)} + V_{(add)} \quad \text{Equation 13}$$

Where:	$V_{(device)}$ -	Gross volume of storage pit and additional storage (m <sup>3</sup> )
	$V_{(storage\ pit)}$ -	Required gross volume of storage pit (m <sup>3</sup> )
	$V_{(add)}$ -	Net additional storage volume, if any (m <sup>3</sup> )

Note: alternative designs may be acceptable pending evidence that the underlying design principle is satisfied. The total storage volume should be provided above the summer (low) groundwater level.

### Step 4 – Device dimensions

Decide the depth of the storage pit and additional storage ( $d_{(device)}$ ) based on the depths to the peat layer and the seasonal high groundwater level. Then, calculate the base area ( $A_{(device)}$ ) using Equation 14:

$$A_{(device)} = \frac{V_{(device)}}{d_{(device)}} \quad \text{Equation 14}$$

Where:	$A_{(device)}$	-	Base area of storage pit and additional storage (m <sup>2</sup> )
	$V_{(device)}$	-	Gross volume of storage pit and additional storage (m <sup>3</sup> )
	$d_{(device)}$	-	Depth of storage pit and additional storage (m)

A standard device has a length-to-width ratio of 2.5:1. If site constraints mean the standard design is not possible, the dimensions may be adjusted as necessary.

### Step 5 – Infiltration trench design

The actual length, width and depth of the trench is determined depending on site constraints. The infiltration trench should be dug at a minimum of 500 mm into the peat layer. Equation 15 should be used to find the required soakage area of the trench:

$$A_{(T,min)} = \frac{V_{(impervious)} \times 1000}{P_{(factored)} \times 60 \times 72} \quad \text{Equation 15}$$

Where:	$A_{(T,min)}$	-	Minimum required soakage area of the trench (m <sup>2</sup> )
	$V_{(impervious)}$	-	Runoff volume from impervious area (m <sup>3</sup> )
	$P_{(factored)}$	-	Tested soakage rate (of peat) with factor of safety applied (L/min/m <sup>2</sup> )

The designer should determine the trench dimensions. Then, Equation 16 and Equation 17 should be used to check whether the actual trench soakage area is sufficient. The trench soakage area is based on the base area of the trench plus half the wall area. The minimum width of the trench should be 1 m. The minimum values for trench length and depth are 1.5 m and 0.5 m respectively.

$$A_{(T,actual)} = L_{(T)}W_{(T)} + L_{(T)}d_{(T)} + W_{(T)}d_{(T)} \quad \text{Equation 16}$$

Where:	$A_{(T,actual)}$	-	Actual soakage area of trench (m <sup>2</sup> )
	$L_{(T)}$	-	Length of trench (m)
	$d_{(T)}$	-	Depth of trench (m)
	$W_{(T)}$	-	Width of trench (m)

$$A_{(T,actual)} \geq A_{(T,min)} \quad \text{Equation 17}$$

Where:	$A_{(T,actual)}$	-	Actual soakage area of trench (m <sup>2</sup> )
	$A_{(T,min)}$	-	Minimum required soakage area of the trench (m <sup>2</sup> )

If the trench dimensions are insufficient, they should be increased and checked again.  $A_{(T,actual)}$  should be close to  $A_{(T,min)}$  to avoid the device over-recharging the groundwater.

Note: If the depth to peat layer or the groundwater level is less than 1 m or greater than 2.5 m, and for any deviation from the standard design, consultation with Auckland Council shall be undertaken to determine whether an amended version of the standard recharge pit or a different site-specific groundwater recharge device is required.

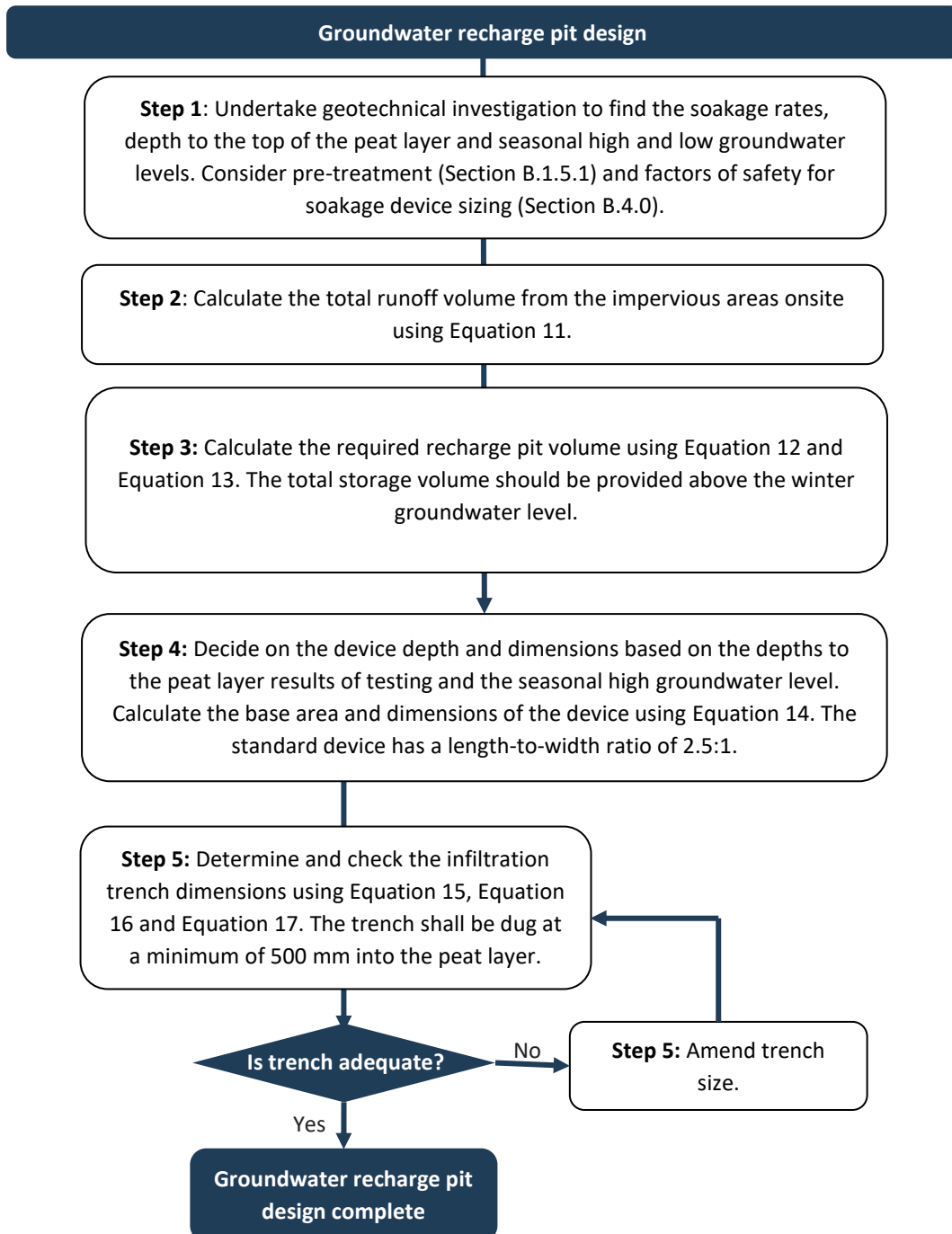

Figure 10: Groundwater recharge pit design process

### C 3.6 Design example

The site is a residential section with 200 m<sup>2</sup> impervious surface that requires a groundwater recharge pit. Design parameters are given below.

**Table 19: Parameters for groundwater recharge pit design example**

Item	Value	Item	Value
Land use category	Residential	Impervious area	200 m <sup>2</sup>
Recharge requirement	First 15 mm of runoff depth	Depth to top of peat	1.6 m below ground surface
Seasonal high groundwater level	1.6 m below ground surface	Aggregate porosity	30%
Factored infiltration rate of peat	0.2 L/min/m <sup>2</sup>		

#### Step 1 – Catchment assessment and device selection

The designer should first gather information about the site and catchment. A site assessment found that:

- A peat layer is present at 1.6 m below the ground surface
- The seasonal high groundwater level is 1.6 m below the ground surface
- There is no contaminated land
- A reticulated stormwater network is available to connect the overflow to
- There are no existing underground services within the site boundaries
- The peat layer has an infiltration rate of 0.2 L/min/m<sup>2</sup>.

Due to the presence of peat, a groundwater recharge pit is required.

#### Step 2 – Required storage volume

Calculate the total runoff volume from the impervious areas onsite, considering the first 15 mm of runoff depth only. This can be done using Equation 11:

$$V_{(impervious)} = A_{(impervious)} \times 0.015 = 200 \times 0.015 = 3m^3$$

#### Step 3 – Device volume

Determine the required volume of the pit using Equation 12 and Equation 13. In this case, the designer chooses not to have additional storage.

$$V_{(storage\ pit)} = \frac{V_{(impervious)} - V_{(add)}}{\phi_{(storage\ pit)}} = \frac{3 - 0}{0.3} = 10m^3$$

$$V_{(device)} = V_{(storage\ pit)} + V_{(add)} = 10 + 0 = 10m^3$$

#### Step 4 – Device dimensions

The designer now decides the depth of the device ( $d_{(device)}$ ) based on the depths to the peat layer and the seasonal high groundwater level. 500 mm of topsoil will be laid on top of the recharge pit. Based on site conditions, the designer decides to have a device depth of 0.6 m, with the top at 0.5 m below ground and the

base at 1.1 m below ground. The base area ( $A_{(device)}$ ) of the storage pit and additional storage can be calculated using Equation 14:

$$A_{(device)} = \frac{V_{(device)}}{d_{(device)}} = \frac{10}{0.6} = 16.67m^2$$

The standard device has a length-to-width ratio of 2.5:1. Therefore, the recharge pit will be 6.45 m long and 2.58 m wide.

### Step 5 – Infiltration trench design

The infiltration trench should be dug at a minimum of 500 mm into the peat layer. Based on the 1.6 m depth to the peat layer, a trench that is 1 m deep will be sufficient (i.e., starting at the base of the storage 1.1 m below ground, and extending 1.0 m beyond this to 2.1 m below ground). The designer also chooses a trench width of 1 m. Equation 15 should be used to size the trench.

$$A_{(T)} = \frac{V_{(impervious)} \times 1000}{P_{(factored)} \times 60 \times 72} = \frac{3 \times 1000}{0.2 \times 60 \times 72} = 3.47 m^2$$

Based on a trench width of 1 m, the required trench length is 1.24 m. Therefore, the standard minimum of 1.5 m for trench length shall be used. Check the trench using Equation 16 and Equation 17:

$$A_{(T,actual)} = L_{(T)}W_{(T)} + L_{(T)}d_{(T)} + W_{(T)}d_{(T)} = 1.5 \times 1 + 1.5 \times 1 + 1 \times 1 = 4m^2$$

$$A_{(T,actual)} \geq A_{(T,min)}; 4 m^2 \geq 3.47 m^2$$

The design is adequate. The final design is a storage pit that is 6.45 m long and 2.58 m wide. It will be 0.6 m deep with 0.5 m of topsoil laid above it. Underneath the pit, an infiltration trench with length, width and depth of 1.5 m, 1 m and 1 m respectively will be provided. The pit extends 0.5 m into the peat layer.

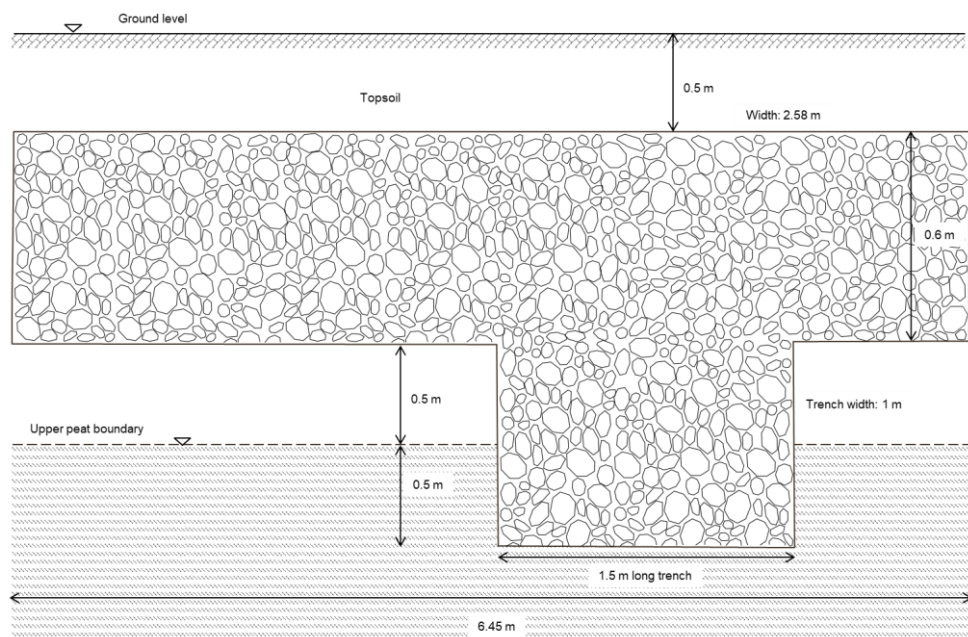

**Figure 11: Sketch of example groundwater recharge pit design**

(not to scale; some components excluded)







# Appendices



# Contents

<b>Appendix A1.0</b>	<b>Soakage testing methodology.....</b>	<b>A-1</b>
Appendix A1.1	Desktop study.....	A-1
Appendix A1.2	Site inspection.....	A-1
Appendix A1.3	General requirements for in-situ soakage testing.....	A-1
Appendix A1.4	Constant head test (general).....	A-3
Appendix A1.5	Constant head test (Talsma-Hallam permeameter).....	A-4
Appendix A1.6	Falling head test.....	A-8
<b>Appendix B1.0</b>	<b>Worksheets.....</b>	<b>B-1</b>
Appendix B1.1	Worksheet 1: Falling Head (Variable Head) Percolation Test (page 1 of 2).....	B-2
Appendix B1.2	Worksheet 2: Soil Constant Head Percolation Test (Permeameter) (page 1 of 2).....	B-6
Appendix B1.3	Worksheet 3: Rockbore Constant Head Percolation Test (page 1 of 2).....	B-8
Appendix B1.4	Worksheet 4: Rockbore design summary.....	B-10
Appendix B1.5	Worksheet 5: Stormwater soakpit design summary.....	B-11
Appendix B1.6	Worksheet 6: Groundwater recharge pit design summary.....	B-12
<b>Appendix C1.0</b>	<b>On-site management operation and maintenance forms.....</b>	<b>C-1</b>
Appendix C1.1	Owner Details.....	C-1
Appendix C1.2	Soakage device details.....	C-1
Appendix C1.3	Layout.....	C-2
Appendix C1.4	As-builts.....	C-3
Appendix C1.5	O&M routine maintenance requirements.....	C-4
Appendix C1.6	O&M specific maintenance requirements for rockbores.....	C-6
Appendix C1.7	O&M specific maintenance requirements for stormwater soakpits.....	C-8
Appendix C1.8	O&M Specific maintenance requirements for groundwater recharge into peat soil....	C-11
<b>Appendix D1.0</b>	<b>Drawings.....</b>	<b>D-1</b>



## Appendices

### Appendix A1.0 Soakage testing methodology

#### Appendix A1.1 Desktop study

The desktop study should collect all relevant legal and planning information (legal title, boundaries, existing and proposed services); relevant environmental information (soils, climate, geology, ecology, hydrology); information on the performance of existing systems on similar sites; information on previously evaluated nearby sites and proposed land uses; and other information for the site and general area. It should include sections covering:

- **Site history:** Including review of historical aerial photography to identify changes in landform, infilled flow paths and the presence of potentially contaminated land and areas of fill
- **Geology, hydrology, and topography:** An overview of the soil, underlying rock, and landscape (topography) features including drainage patterns across the site. This should draw from sources including geology and soils maps, the New Zealand Geotechnical Database, and records of nearby developments
- **Groundwater:** An assessment of likely groundwater depth, seasonal range of levels, flow direction and rate, and potential contamination
- **Natural hazards:** An assessment of erosion, land slippage and other geotechnical hazards
- **Infrastructure:** Infrastructure information, e.g., existing, or planned buildings, retaining walls and buried services (power, gas)
- **Site plans:** Intended on-site features
- **Assessment of effects:** An assessment of potential off-site effects such as impacts on groundwater levels, risk of mounding, buoyancy, exacerbated surface flooding, downstream seepages. This includes an assessment of cumulative effects on existing soakage systems.

The desktop study shall be reported in full to the satisfaction of the regulatory authority, and shall indicate the need for, or extent of, any further detailed site or soil assessment, together with the reasons for such judgements.

#### Appendix A1.2 Site inspection

A site inspection is required to validate the findings of the desk study. If the desktop study is found to be valid, physical testing can be undertaken to provide the parameters required to design the soakage device.

#### Appendix A1.3 General requirements for in-situ soakage testing

Soakage tests are normally carried out in boreholes. These are commonly drilled in rock using a drilling rig or hand augered in soil. Where drilling is not possible due to ground conditions (such as scoria and peat), then



the test should be carried out in a test pit. A technical specification for undertaking this test, based on the methodology described in the *New Zealand Ground Investigation Specification* (Ministry of Business, Innovation and Employment & New Zealand Geotechnical Society, 2017), is presented in this Appendix.

Soakage testing should be undertaken by a suitably qualified and experienced person. These may include professional engineers, soil scientists, drainage contractors or plumbers with appropriate training, competence, and experience in design and installation practice. They should ensure that they:

- Have attended an appropriate accredited training programme
- Are familiar with any regulatory requirements for site evaluation
- Are responsible for all work to evaluate the capacity of a site and its soil for accepting stormwater
- Certify that the evaluation procedures have been undertaken in accordance with this guideline
- Identify cultural concerns or constraints.

In addition, if the soakage rate is found to be less than 1 l/min/m<sup>2</sup>, the testing must be done by a representative of an IANZ certified laboratory following their quality assurance processes. Where testing shows a soakage rate of less than 0.5 l/min/m<sup>3</sup>, soakage is not appropriate and there may be limited benefit for groundwater recharge.

The following requirements apply to all tests:

- The location of the borehole or test pit should correspond with the position of the proposed soakage device, and the tests shall be performed at minimum to the desired depth of the soakage device
- Geological layers and soil types should be recorded in bore logs in accordance with New Zealand Geotechnical Society guidelines
- Water table levels should be recorded, preferably via a piezometer. If no piezometer has been installed, the bore or pit should be left open until the groundwater level has stabilised
- At least one borehole or test pit is required for every soakage device
- Bores or test pits positioned within 10 m of each other should be tested simultaneously to ensure that the effect of interference is accounted for
- Unless otherwise noted in the test methodology, all boreholes or test pits in soil should be pre-soaked prior to testing until a constant infiltration result is achieved to simulate conditions during prolonged wet periods and heavy rainfall.

Requirements for boreholes in soil:

- Boreholes in soil should be between 100 mm to 150 mm in diameter
- Remove all loose materials and smeared clays from the sides of the hole to provide a natural soil interface through which water can infiltrate
- If collapse of a drilled hole seems likely, a perforated PVC pipe should be used to case and hold it open. If scouring of a test pit seems likely, about 50 mm of sand or fine gravel should be added to the pit to protect the bottom from scouring or sediment blinding
- If collapse of a drilled hole seems likely, a perforated PVC pipe or equivalent should be used to case and hold it open

- All boreholes or test pits in soil should be pre-soaked prior to testing until a constant infiltration result is achieved to simulate conditions during prolonged wet periods and heavy rainfall. Testing should be continued until the drop in water level becomes “constant” across three consecutive readings, or until the last drop in level differs by less than 10% of the preceding drop (as per NZS1547 (Standards New Zealand, 2012)). This will normally provide adequate time for the soils surrounding the hole to become saturated, and for any clay soils to swell to ensure that any cavities are filled before the testing begins.

Requirements for boreholes in rock:

- Boreholes in rock should be between 100 mm to 150 mm in diameter
- Holes in rock areas must be pre-soaked to ensure that any cavities in the rock are filled before testing begins. The hydrant must be open at a high flow rate for a minimum of 10 minutes before testing begins and the volume of discharged water recorded for context.
- Permission from Watercare Services should be obtained for use of a fire hydrant
- The use of a fire hydrant is only appropriate where the soakage rate is less than the maximum flow rate provided by the hydrant (usually 20 L/s). Water trucks should be used when it is necessary to prove higher flow rates than available with a hydrant.

Requirements for test pits (soil only):

- Test pits are only intended for use in scoria, sand, or similar granular materials. Testing in a screened bore is often an appropriate alternative option for these materials.
- A test pit should be excavated to the bottom level of the proposed soakage device with a minimum base area of 1 m<sup>2</sup>. The walls of the test pit should be laid back at a suitable angle to prevent caving in and erosion during the test
- All boreholes or test pits in soil should be pre-soaked prior to testing until a constant infiltration result is achieved to simulate conditions during prolonged wet periods and heavy rainfall. Testing should be continued until the drop in water level becomes “constant” across three consecutive readings, or until the last drop in level differs by less than 10% of the preceding drop (as per NZS1547 (Standards New Zealand, 2012)). This will normally provide adequate time for the soils surrounding the hole to become saturated, and for any clay soils to swell to ensure that any cavities are filled before the testing begins.

## Appendix A1.4 Constant head test (general)

Constant head tests determine the soakage rate ( $p_{(\text{constant})}$ ) by maintaining a constant head of water in an unlined test pit or borehole. Water that drains into the ground is replenished at the same rate using a fire hydrant or water truck (in very permeable zones  $>3 \times 10^{-4}$  m/s) or a Talsma-Hallam permeameter (in lower permeability zones from  $3 \times 10^{-4}$  to  $1 \times 10^{-7}$  m/s). The stabilised flow required to keep water at a constant level in the hole is measured as the effective soakage rate. This method is most suitable for soakage into a volcanic rock aquifer where soakage rates can be very high.

The constant head test is based on Darcy’s Law and is an ‘above the water table’ test. The surrounding ground should be unsaturated or have negative pore-water pressures. The method does not apply if these conditions are not met – it is not suitable for use below the water table.



If the depth  $S$  to an impermeable layer (see Figure G1) is less than  $2H$ , then advice shall be sought from a suitably qualified and experienced person. An impermeable layer is defined as having a permeability less than 10% of the adjacent overlying layer.

### **Appendix A1.5      Constant head test (Talsma-Hallam permeameter)**

If the depth  $S$  to an impermeable layer (see Figure A1) is less than  $2H$ , then advice shall be sought from a suitably qualified and experienced person. An impermeable layer is defined as having a permeability less than 10% of the adjacent overlying layer.

The apparatus and equipment required are:

- 1) **Permeameter.** This is composed of (see Figure A1):
  - a) A reservoir made of clear, transparent, rigid tube, Polycarbonate pipe with an inside diameter of 30-45 mm makes a suitable reservoir.
  - b) A rubber bung to form an airtight seal.
  - c) An air-inlet tube that extends almost to the bottom of the reservoir, sealed airtight into the rubber bung. Polycarbonate pipe with outside diameter of 9.5 mm and inside diameter of 6.0 mm is suitable as the air inlet tube.
  - d) A millimetre graduation scale on the outside of the reservoir along its full length, highest numbers at the top. The 0 cm mark is set at the level of the opening of the air inlet A1 tube.

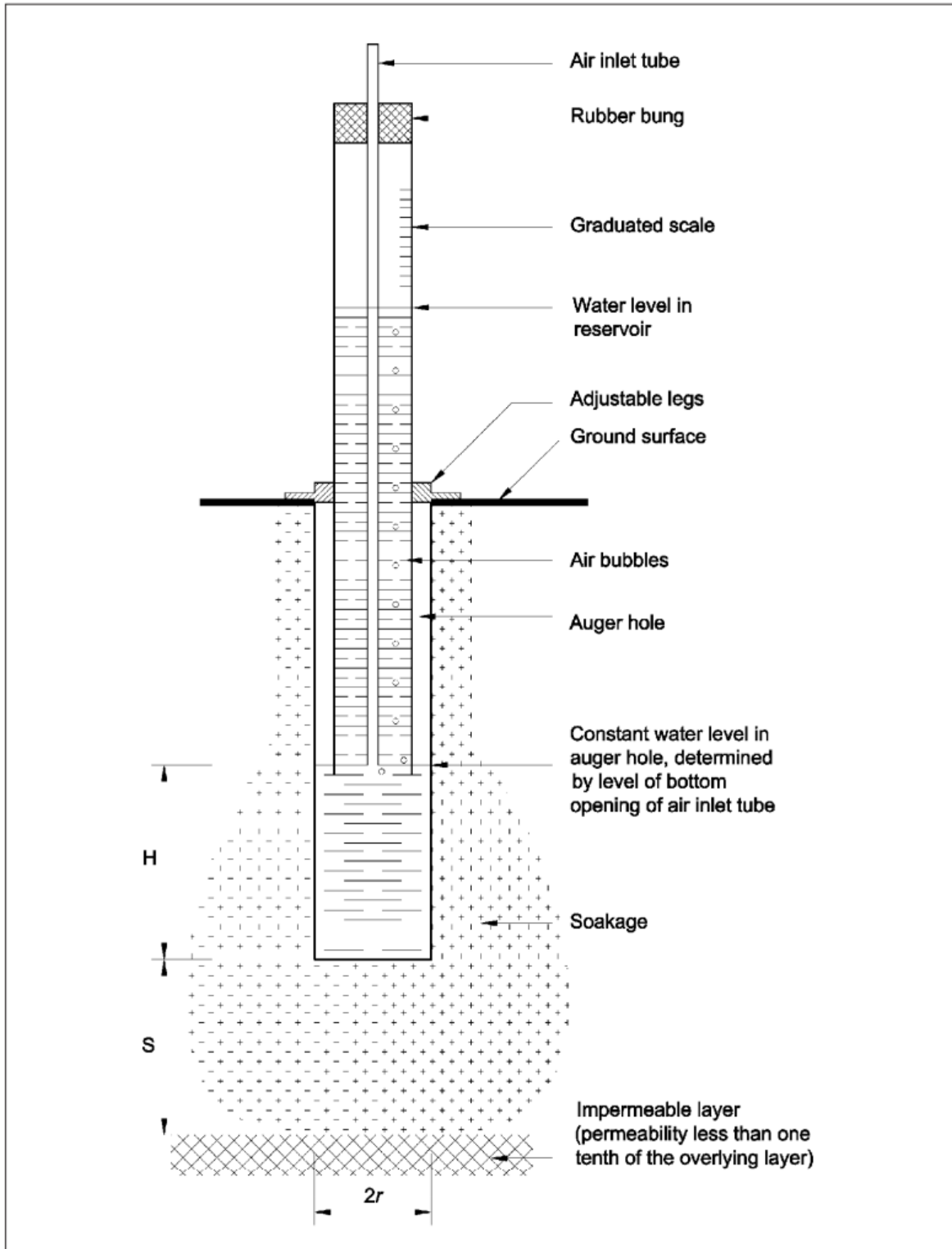

where:

H = depth of water in test hole

S = the depth to an underlying impermeable layer

r = radius of the test hole

Figure A1: Permeameter setup (after AS/NZS1547:2012 Figure G1)

- 2) **Tripod.** A tripod or clamping device with adjustable legs used to hold the permeameter firmly and vertically over the centre of the hole.
- 3) **Suction flask.** An airtight vessel used to remove excess water from an overfilled test hole. It is composed of:
  - a) A flask, volume at least 1 litre with an air/watertight lid. Two pipes, outside diameter of 12.5 mm, are fitted into the lid of the flask. One pipe is to reach close to the bottom of the flask. The other extends to be just inside the flask below the lid. Both pipes extend to 50 – 100 mm above the lid.
  - b) Flexible tubing is fitted to the pipes above the lid of the jar:
    - i) The pipe that reaches to the bottom of the flask is fitted with flexible tubing approximately 0.6 m long, at the end of which is attached another length of rigid, transparent pipe approximately 0.4 m in length
    - ii) The pipe that reaches to just below the lid is fitted with approximately 0.5 m of flexible tubing.
  - c) All connections shall be sealed and airtight.
- 4) **Anti-scouring device.** Water shall be added to the test hole in a manner that minimises turbulence in the water and reduces scouring of the lower part of the test hole. Equipment to achieve this is shown in Figure A2. A wad of filter cloth is used to gently disperse the water. The tube used to introduce water to the hole shall just fit inside the test hole and be long enough to protrude after it has been lowered into the hole.

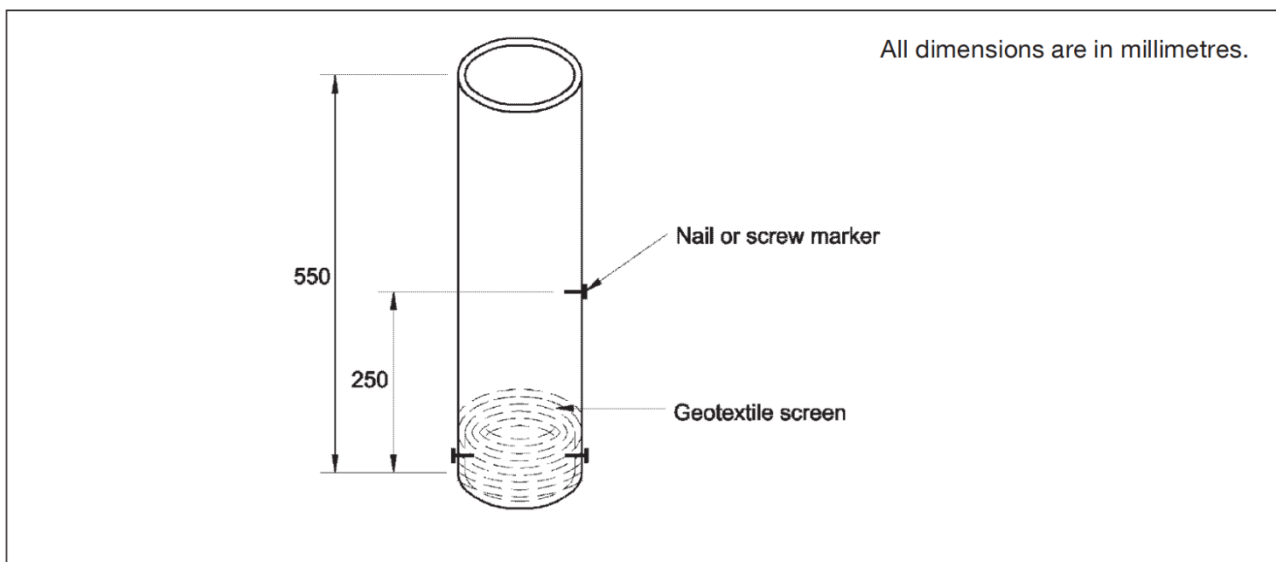

**Figure A2: Anti-scouring device setup (after AS/NZS1547:2012 figure G2)**

- 5) **Auger/s with a minimum diameter of 75 mm.** Usually a 75 mm auger will produce a 90 mm diameter hole. A sharp cutting edge is required to minimise changes to the permeability of the surrounding soil. Powered augers should be avoided as they cause more disturbance and smearing of the borehole wall.

## 6) Stopwatch:

The test procedure for single holes is:

- 1) Excavate a cylindrical hole to the test zone using an auger. In general, the auger depth should be to the anticipated depth of the proposed soakage device. Do not over-fill the auger as this tends to compact the soil around the hole, changing its permeability characteristics.
- 2) Overnight pre-soaking of the test hole is not necessary, as the test indicates when stable infiltration has occurred. In non-reactive soils, infiltration usually stabilises within an hour of the start of the test. In moist soil after recent rainfall, the infiltration may stabilise almost immediately.
- 3) Measure the final depth of the hole. Erect the permeameter by adjusting the tripod so that the air inlet will be approximately 250 mm above the bottom of the hole, or higher if a larger test zone is required to represent the likely design of the soakage device. Remove the permeameter from the hole.
- 4) Insert the anti-scouring device. Fill the hole to approximately the level of the air inlet. This is the level of water to be maintained in the test hole during testing. Remove the anti-scouring device.
- 5) Invert the permeameter and fill it with water. Temporarily close/cover the bottom end of the reservoir and turn it upright. Place the bottom of the reservoir directly over the test hole, while keeping the outlet closed. Quickly remove the temporary cover and immediately lower the reservoir to rest on its stand and fix in place.
- 6) Use the suction flask to remove excess water from the test hole. Water is removed from the hole by sucking air out of the flask through the short end of the flexible tubing.
- 7) When the water level in the hole drops sufficiently, air will enter the reservoir from the air inlet tube. Once the first air bubble rises in the reservoir, the test measurements commence.
- 8) Read the level of water in the reservoir at predetermined fixed-time intervals, and record on Worksheet 2. The length of the fixed-time interval may be varied to suit the permeability of the soil. In high permeability soil, these readings may be every ten seconds, and in very low permeability soil, may be once every hour.
- 9) Continue with the readings until the drop in water level becomes constant over three successive readings (taken as a difference in drop of less than 10% from the preceding drop). Sometimes, particularly when the interval between readings is short, a bubble may rise just before or after alternate readings resulting in a drop that fluctuates from high to low with each measurement. Stable infiltration is demonstrated when the sum of the high and low readings is within 10% of the sum of the following high and low readings.

Multiple measurements can be run simultaneously if the permeability of the soil is not too high. The basic test method and apparatus used is as for individual test holes, e.g., if a series of eight tests is to be done, the test procedure is:

- 1) Prepare eight auger holes of approximately the same depth and set the tripods at the correct height along each of the reservoir pipes to maintain the same depth of water in all holes.
- 2) Place the reservoir pipes next to the holes.
- 3) Using the anti-scouring device, fill all holes to the required test depth.
- 4) Fill each reservoir and immediately insert it into the hole.

- 5) Make the round of all the test holes with the suction flask to get all reservoirs to the stake of the first rising air bubble.
- 6) Set a stopwatch at 0:00 time and start the time. Read the water level in pipe 1 and record it. Move to pipe 2 and read the water level at 0:30 min. Move to pipe 3 and read the water level at 1:00 min. Continue to do this for all pipes. After 3:30 min. all eight pipes have been read. Wait until the time for the next reading of pipe 1, and then read the other pipes in the same order using the same time interval.

In average soils it should take no more than 2.5 hours to complete a set of eight tests. Excavating the holes often requires most of that time.

#### **Additional comments:**

- Permission from Watercare Services should be obtained for use of a fire hydrant
- The use of a fire hydrant is only appropriate where the soakage rate is less than the maximum flow rate provided by the hydrant (usually 20 L/s). Water trucks should be used when it is necessary to prove higher flow rates than available with a hydrant.

## **Appendix A1.6      Falling head test**

Falling head percolation tests determine the percolation rate ( $P_{(falling)}$ ) of an area by filling a borehole or test pit with water and recording the rate at which it drains away. Constant head tests are preferred, where appropriate, because they tend to give more accurate results.

The test procedure for single holes is:

- 1) Excavate a cylindrical hole to the test zone using an auger. Do not over-fill the auger as this tends to compact the soil around the hole, changing its permeability characteristics.
- 2) To replicate conditions under which the soakage device will operate, pre-soak the ground around the hole. Completely fill the hole with water and maintain this level from a suitable water supply. Measure the volume of water being added to the hole at least every hour. If the volume added has been stable for at least two hours, the pre-soaking may be terminated after four hours. If the volume added per hour is changing by more than 5% between hourly measurements, continue until the rate of change drops to less than 5% or until 17 hours is reached.
- 3) Wait for the water level to fall until it is at the top level of the proposed soakage device (or 400 mm below ground level if this has not been defined).
- 4) Measure the depth to water from ground level at the following frequencies:
  - a. From 0 - 5 minutes: every 30 seconds
  - b. From 5 - 10 minutes: every 1 minute
  - c. From 10 - 20 minutes: every 2 minutes
  - d. From 20 minutes: every 5 minutes
- 5) Continue measuring the drop in groundwater level until the bore is empty, or until there is no level change in three consecutive measurements (whichever comes first).

## Appendix B1.0 Worksheets

**Appendix B1.1      Worksheet 1: Falling Head (Variable Head) Percolation Test (page 1 of 2)**

Client project #: \_\_\_\_\_ Client: \_\_\_\_\_  
 Test company: \_\_\_\_\_ Method: \_\_\_\_\_  
 Site address: \_\_\_\_\_ Date: \_\_\_\_\_ Time: \_\_\_\_\_  
 Borehole number: \_\_\_\_\_ Test number: \_\_\_\_\_ of total no. \_\_\_\_\_  
 Position X: \_\_\_\_\_ Position Y: \_\_\_\_\_ Elevation: \_\_\_\_\_  
 Other boreholes within influence distance (test simultaneously): \_\_\_\_\_

**1. Attach the following (tick once attached):**

Log of hole showing depth, rock type and moisture content       Graph of water level against time       Site-plan showing location of the hole(s)

**2. General information**

Depth of borehole, **H**: \_\_\_\_\_ m      If casing is required: \_\_\_\_\_  
 Diameter of bore, **D**: \_\_\_\_\_ m      Depth of casing: \_\_\_\_\_ m  
 Pre-test groundwater level: \_\_\_\_\_ mBGL<sup>1</sup>      Diameter of casing: \_\_\_\_\_ m

**3. Test log**

Interval start time (min:sec)	Interval length (min) x	Water depth at interval start (mBGL)	Water level drop over interval (m) y	Interval gradient (m/min) y/x	Notes / problems encountered
0:00	0.5				
0:30	0.5				
1:00	0.5				
1:30	0.5				
2:00	0.5				
2:30	0.5				
3:00	0.5				
3:30	0.5				
4:00	0.5				
4:30	0.5				
5:00	1				
6:00	1				
7:00	1				
8:00	1				
9:00	1				
10:00	2				
12:00	2				
14:00	2				
16:00	2				
18:00	2				
20:00	5				
25:00	5				
30:00	5				
35:00	5				
40:00	5				
45:00	5				
50:00	5				
55:00	5				
60:00	5				



**Worksheet 1: Falling Head (Variable Head) Percolation Test (page 2 of 2)**

Borehole number: \_\_\_\_\_ Test number: \_\_\_\_\_ of total no. \_\_\_\_\_

**1. Minimum gradient<sup>1</sup>**

Minimum gradient<sup>2</sup> =  $\frac{y}{x}$

= \_\_\_\_\_ m/min

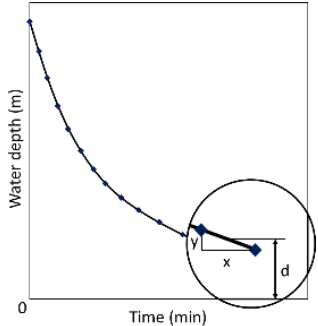

**2. Percolation rate (L/min/m<sup>2</sup>)**

Percolation rate<sup>3</sup> =  $P_{(total)} = \frac{D \times gradient \times 1000}{4 \times d}$  = \_\_\_\_\_ L/min/m<sup>2</sup>

FoS for consequences of failure<sup>4</sup> =  $F_{(c)}$  = \_\_\_\_\_

FoS for testing uncertainty<sup>5</sup> =  $F_{(u)}$  = \_\_\_\_\_

Total Factor of Safety =  $F_{(total)} = F_{(c)} \times F_{(u)}$  = \_\_\_\_\_

Factored percolation rate =  $P_{(factored)} = \frac{P_{(total)}}{F_{(total)}}$  = \_\_\_\_\_ L/min/m<sup>2</sup>

Additional comments:

Name of test operator: \_\_\_\_\_ Date: \_\_\_\_\_

Qualification: \_\_\_\_\_ Signature: \_\_\_\_\_

Notes:

<sup>1</sup> mBGL = metres below ground level

<sup>2</sup> A straight line interpolation between the two points on the water depth vs time table giving the lowest gradient is required. This will normally be the last two points. If the rate of change during the test has not stabilised for at least the last three measurements, then the test shall be repeated.

<sup>3</sup> d = distance in m between the midpoint of the last two readings and the base of the borehole

<sup>4</sup> See Section B.4.0 Table 5 for factors of safety.

<sup>5</sup> See Section B.4.0 Table 6 for factors of safety.



### Worksheet 1: Falling Head (Variable Head) Percolation Test (template graph)

Borehole number: \_\_\_\_\_ Test number: \_\_\_\_\_ of total no. \_\_\_\_\_

This template graph is provided for easy graphical presentation of results for a 60 minute test. Alternative formats are acceptable. Hand-write the depths on the x-axis, and over-write the y-axis for tests of a different duration.

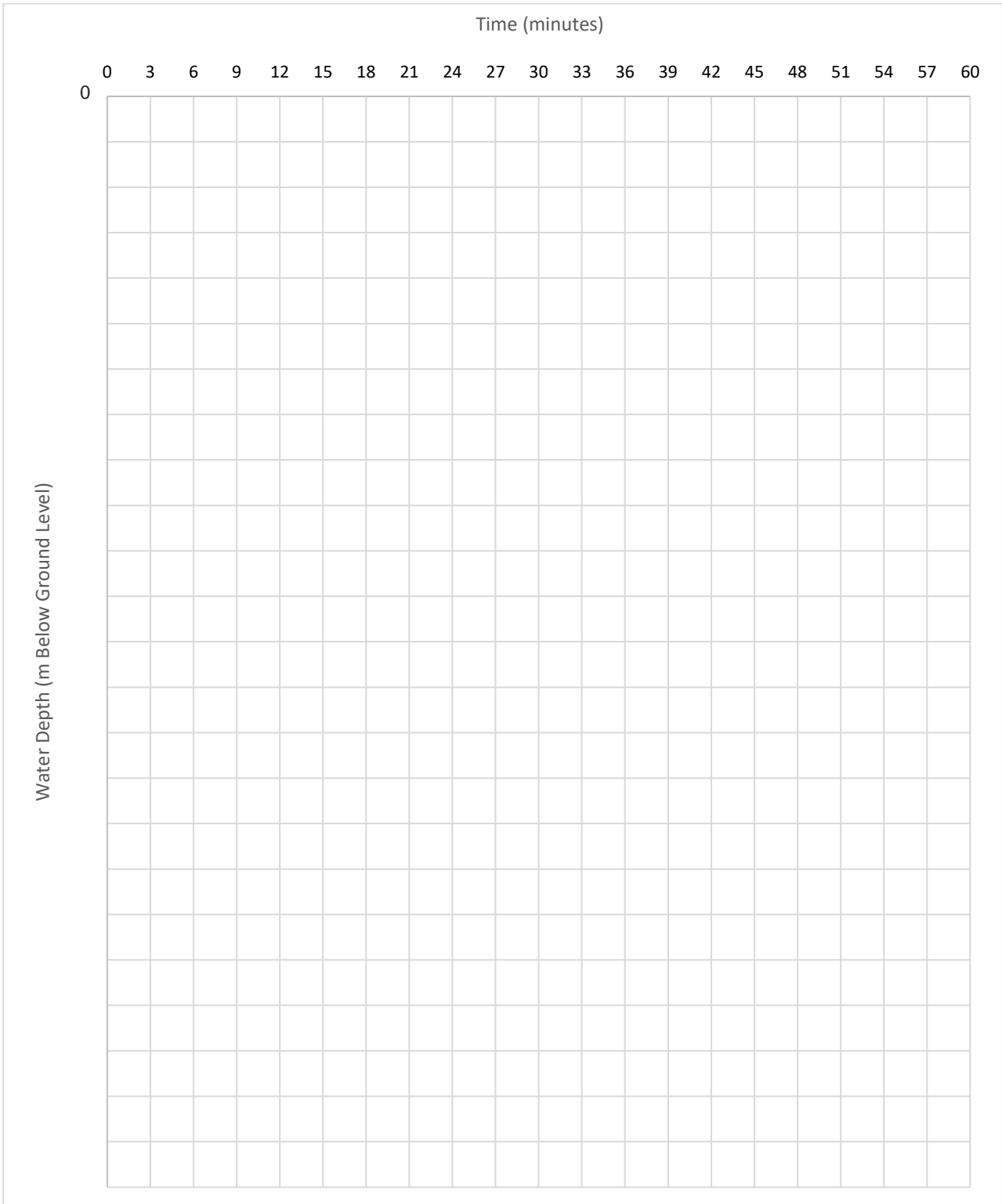



**Worksheet 2: Soil Constant Head Percolation Test (Permeameter) (page 2 of 2)**

Borehole number: \_\_\_\_\_ Test number: \_\_\_\_\_ of total no. \_\_\_\_\_

<b>1. Final capacity of borehole in soil</b>	
Capacity of bore <sup>2</sup>	= $p_2 = \text{Flowrate}$ = _____ L/s

<b>2. Percolation rate</b>	
Soakage surface	= <i>borehole base area + borehole wall area</i> = $(\pi \times (\frac{D}{2})^2) + (H - W) \times \pi \times D$ = _____ m <sup>2</sup>
Percolation rate	= $P_{(total)} = \frac{p_2 \times 60}{\text{soakage surface}}$ = _____ L/min/m <sup>2</sup>
FoS for consequences of failure <sup>3</sup>	= $F_{(c)}$ = _____
FoS for testing uncertainty <sup>4</sup>	= $F_{(u)}$ = _____
Total Factor of Safety	= $F_{(total)} = F_{(c)} \times F_{(u)}$ = _____
Factored percolation rate	= $P_{(factored)} = \frac{P_{(total)}}{F_{(total)}}$ = _____ L/min/m <sup>2</sup>

General comments (indications of waterlogging, soil structure, biological pores, etc.):

Name of test operator: _____	Date: _____
Qualification: _____	Signature: _____
Notes:	
<sup>1</sup> mBGL = metres below ground level	
<sup>2</sup> Use the end of test flowrate. Repeat the test at least twice until the end of test flow rate is consistent to ±10%.	
<sup>3</sup> See Section B.4.0 Table 5 for factors of safety.	
<sup>4</sup> See Section B.4.0 Table 6 for factors of safety.	

**Appendix B1.3      Worksheet 3: Rockbore Constant Head Percolation Test (page 1 of 2)**

Client project #: \_\_\_\_\_ Client: \_\_\_\_\_  
 Test company: \_\_\_\_\_ Method: \_\_\_\_\_  
 Site address: \_\_\_\_\_ Date: \_\_\_\_\_ Time: \_\_\_\_\_  
 Borehole number: \_\_\_\_\_ Test number: \_\_\_\_\_ of total no. \_\_\_\_\_  
 Position X: \_\_\_\_\_ Position Y: \_\_\_\_\_ Elevation: \_\_\_\_\_  
 Other boreholes within influence distance (test simultaneously): \_\_\_\_\_

**1. Attach the following (tick once attached):**  
 Log of hole showing depth, rock type and moisture content     Site-plan showing location of the hole(s)

**2. General information**  
 Depth of hole: \_\_\_\_\_ m      Presoak duration: \_\_\_\_\_ min  
 Radius of hole: \_\_\_\_\_ m      Presoak volume: \_\_\_\_\_ litres  
 Pre-test groundwater level: \_\_\_\_\_ mBGL<sup>1</sup>      Water source: \_\_\_\_\_  
 Depth to any impermeable layer: \_\_\_\_\_ m      Weather at time of test: Raining    Rain in last 24hr    Dry

**3. Test log (continue test until flow rate is stable to ±10% over three time intervals)**

Interval Start Time (min:sec)	Interval length (seconds) x	Flow meter reading at start of interval	Volume infiltrated during interval (V) (litres)	Flow rate during interval =V <sub>i</sub> / x (L/s)
0:00	60			
1:00	60			
2:00	60			
3:00	60			
4:00	60			
5:00	60			
6:00	60			
7:00	60			
8:00	60			
9:00	60			
10:00	300			
15:00	300			
20:00	300			
25:00	300			
30:00	300			
35:00	300			
40:00	300			
45:00	300			
50:00	300			
55:00	300			

**Worksheet 3: Rockbore Constant Head Percolation Test (page 2 of 2)**

Borehole number: \_\_\_\_\_ Test number: \_\_\_\_\_ of total no. \_\_\_\_\_

1. Capacity of test borehole (use minimum value recorded in test interval)			
Unfactored bore capacity <sup>2</sup>	$= P = \text{Min Flowrate}$	=	L/s
FoS for consequences of failure <sup>3</sup>	$= F_{(c)}$	=	
FoS for testing uncertainty <sup>4</sup>	$= F_{(u)}$	=	
Total Factor of Safety	$F_{(total)} = F_{(c)} \times F_{(u)}$	=	
Factored percolation rate	$P_{(factored)} = \frac{P}{F_{(total)}}$	=	L/s

General comments (indications of waterlogging, rock structure, etc.):

Name of test operator: \_\_\_\_\_ Date: \_\_\_\_\_

Qualification: \_\_\_\_\_ Signature: \_\_\_\_\_

Notes:

<sup>1</sup> mBGL = metres below ground level

<sup>2</sup> Use lowest tested flowrate (usually last interval). Repeat the test at least twice until the end of test flow rate is consistent to ±10%.

<sup>3</sup> See Section B.4.0 Table 5 for factors of safety.

<sup>4</sup> See Section B.4.0 Table 6 for factors of safety.



## Appendix B1.4 Worksheet 4: Rockbore design summary

Site Address: \_\_\_\_\_  
 Designer: \_\_\_\_\_ Date: \_\_\_\_\_  
 Qualification: \_\_\_\_\_ Signed: \_\_\_\_\_  
 Reviewer: \_\_\_\_\_ Date: \_\_\_\_\_  
 Qualification: \_\_\_\_\_ Signed: \_\_\_\_\_

### Step 1. Site assessment

Number of boreholes (Manhole 1): \_\_\_\_\_

Manhole 1 diameter: \_\_\_\_\_ mm

Number of boreholes (Manhole 2) – where required: \_\_\_\_\_

Manhole 2 diameter – where required: \_\_\_\_\_ mm

### Step 2. Hydrological requirement

Peak discharge rate (Use TP108 Method),  $Q_{(S)}$ <sup>1</sup> \_\_\_\_\_ L/s

### Step 3. Soakage rate (after factor of safety is applied)

Borehole Factored Soakage Rate Details<sup>2</sup>

Manhole 1		Manhole 2	
Bore 1, $p_1$	L/s	Bore 5, $p_5$	L/s
Bore 2, $p_2$	L/s	Bore 6, $p_6$	L/s
Bore 3, $p_3$	L/s	Bore 7, $p_7$	L/s
Bore 4, $p_4$ <sup>3</sup>	L/s	Bore 8, $p_8$ <sup>3</sup>	L/s
Total soakage rate with factor of safety applied $p_{(factored)}$			L/s
$p_{(factored)} \geq Q_{(S)}$ ? <sup>3</sup>		<input type="checkbox"/> YES	<input type="checkbox"/> NO
If yes, design is complete. If no, consider drilling more bores or using multiple devices.			

<sup>1</sup>Attach TP108 worksheet while submitting this worksheet for approval

<sup>2</sup>The soakage rate of every borehole shall be determined in L/s

<sup>3</sup>The designer may choose to have an extra borehole drilled for future development. The bore should be tested, but the soakage rate that it contributes should not be included in the Total Factored Soakage Rate for rockbore sizing.

## Appendix B1.5 Worksheet 5: Stormwater soakpit design summary

Site Address: \_\_\_\_\_  
 Designer: \_\_\_\_\_ Date: \_\_\_\_\_  
 Qualification: \_\_\_\_\_ Signed: \_\_\_\_\_  
 Reviewer: \_\_\_\_\_ Date: \_\_\_\_\_  
 Qualification: \_\_\_\_\_ Signed: \_\_\_\_\_

### Step 1. Site assessment

Soakpit length $L_{(S)}$ <sup>1</sup>	=	m
Soakpit width $W_{(S)}$ <sup>1</sup>	=	m
Soakpit depth $d_{(S)}$	=	m

### Step 2. Hydrological requirement

Peak discharge rate (Use TP108 Method), $Q_{(S)}$ <sup>2</sup>	=	L/s
--	---	-----

### Step 3. Soakpit design

Soakage area $A_{(S)}$	=	m <sup>2</sup>
Porosity of soakpit aggregate $\emptyset_{(soakpit)}$	=	%
Net additional storage volume, if any $V_{(add)}$ <sup>3</sup>	=	m <sup>3</sup>
Available storage volume in soakpit $V_{(soakpit)}$	=	m <sup>3</sup>

### Step 4. Storage volume

Soakage rate with factor of safety applied $P_{(factored)}$	=	L/min/m <sup>2</sup>
Coefficient of storage $C_{(storage)}$	=	
Coefficient of required volume $C_{(req)}$ <sup>4</sup>	=	m <sup>3</sup> s/L
Required storage volume $V_{(req)}$	=	m <sup>3</sup>
$V_{(soakpit)} \geq V_{(req)}$ ?	<input type="checkbox"/> YES	<input type="checkbox"/> NO
If yes, continue the design below. If no, review design and increase soakpit dimensions.		
Time to drain $T_{(drain)}$	=	hr
$T_{(drain)} \leq 24$ hr?	<input type="checkbox"/> YES	<input type="checkbox"/> NO
If yes, design is complete. If no, review design and increase soakpit dimensions.		

<sup>1</sup>Minimum soakpit length = 1.0 m, minimum soakpit width = 0.5 m

<sup>2</sup>Attach TP108 worksheet while submitting this worksheet for approval

<sup>3</sup>Use only if providing additional storage

<sup>4</sup>Use the graph for coefficients of required volume in Figure 6

## Appendix B1.6 Worksheet 6: Groundwater recharge pit design summary

Site Address: \_\_\_\_\_

Designer: \_\_\_\_\_ Date: \_\_\_\_\_

Qualification: \_\_\_\_\_ Signed: \_\_\_\_\_

Reviewer: \_\_\_\_\_ Date: \_\_\_\_\_

Qualification: \_\_\_\_\_ Signed: \_\_\_\_\_

### Step 1. Site assessment

Porosity of aggregate material $\phi_{(\text{storage pit})}$	=	%
Depth to top of peat layer	=	mBGL
Depth to seasonal high groundwater table	=	mBGL
Depth to seasonal low groundwater table	=	mBGL

### Step 2. Required storage volume

Impervious area $A_{(\text{impervious})}$	=	$\text{m}^2$
Required storage volume $V_{(\text{impervious})}$	=	$\text{m}^3$

### Step 3. Device volume

Required storage volume in storage pit $V_{(\text{storage pit})}$	=	$\text{m}^3$
Net additional storage volume, if any $V_{(\text{add})}^1$	=	$\text{m}^3$
Gross volume of storage pit and additional storage $V_{(\text{device})}$	=	$\text{m}^3$

### Step 4. Device dimensions

Depth of storage pit and additional storage $d_{(\text{device})}$	=	m
Base area of storage pit and additional storage $A_{(\text{device})}$	=	$\text{m}^2$
Width of storage pit and additional storage $W_{(\text{device})}^2$	=	m
Length of storage pit and additional storage $L_{(\text{device})}^2$	=	m

### Step 5. Trench design

Consult with Auckland Council for any deviation from the standard design, or if the depth to peat or the groundwater level is less than 1 m or greater than 2.5 m. Trench should extend 500 mm into the peat layer.

Factored soakage rate of peat $P_{(\text{factored})}$	=	L/min/ $\text{m}^2$
Minimum required trench soakage area $A_{(\text{T,min})}$	=	$\text{m}^2$
Length of trench $L_{(\text{T})}$	=	m
Width of trench $W_{(\text{T})}$	=	m
Depth of trench $d_{(\text{T})}$	=	m
Actual soakage area of trench $A_{(\text{T,actual})}$	=	$\text{m}^2$
Check $A_{(\text{T,actual})} \geq A_{(\text{T,min})}$	<input type="checkbox"/> YES	<input type="checkbox"/> NO

If yes, design is complete. If no, review design and increase groundwater recharge pit dimensions

<sup>1</sup>Use only if providing additional storage

<sup>2</sup>The length-to-width ratio is 2.5:1

## Appendix C1.0 On-site management operation and maintenance forms

### Soakage/Groundwater Recharge Soakpit Device O&M Plan

Building consent number: \_\_\_\_\_

#### Appendix C1.1 Owner Details

- 1) Owner's name: \_\_\_\_\_
- 2) Mailing address: \_\_\_\_\_  
 \_\_\_\_\_ Postcode: \_\_\_\_\_
- 3) Physical address of land where soakage device is located:  
 \_\_\_\_\_  
 \_\_\_\_\_ Postcode: \_\_\_\_\_  
 Lot number: \_\_\_\_\_ DP number: \_\_\_\_\_
- 4) Drainlayer: \_\_\_\_\_ Registration number: \_\_\_\_\_
- 5) Date submitted: \_\_\_\_\_

#### Appendix C1.2 Soakage device details

Ref. No	Type	Size	Location	Runoff Area & Source*

**Note:**

- Ref No. – from Drawings, if applicable
- Type – recharge pit, soakpit, rock borehole
- Size – e.g., 1200 mm Ø for rockbore soakhole manhole chamber, or 5 m L x 2 m W x 1 m D for soakpit
- Location – brief description of where soakage device is located e.g., in LH carriageway, N-side of property in lawn, etc
- Runoff area & source – e.g., 50 m<sup>2</sup> roof, 100 m<sup>2</sup> paved area.

**Appendix C1.3      Layout**

*Sketch soakage device layout or insert copy of layout plan*

## **Appendix C1.4 As-builts**

Copy of as-builts attached as pdf

## Appendix C1.5 O&M routine maintenance requirements

### (a) Monitoring and inspection programme:

<b>Routine monitoring and inspections are required to:</b>	<ul style="list-style-type: none"> <li>• Develop a condition history</li> <li>• Improve scheduling efficiency</li> <li>• Apply preventative maintenance</li> </ul>
<b>Inspection records are to be used to:</b>	<ul style="list-style-type: none"> <li>• Determine where special maintenance conditions exist</li> <li>• Determine optimal frequencies for future inspection and maintenance</li> <li>• Establish scheduled and unscheduled maintenance provisions</li> <li>• Assure soakage device operation and aesthetics</li> </ul>
<b>Suggested inspection frequency</b>	<ul style="list-style-type: none"> <li>• The owner will be responsible for conducting inspections (or having them done on his/her behalf) with the soakage/groundwater recharge soakpit device “as-built” plans in hand, generally at the following intervals (noting that this may vary, depending on site-specific conditions):             <ul style="list-style-type: none"> <li>○ Quarterly basis for the first 2 years and after large storm events</li> <li>○ Minimum of every 2 years after that.</li> </ul> </li> <li>• Pre-treatment devices should be inspected at the following minimum frequencies:             <ul style="list-style-type: none"> <li>○ Quarterly basis for the first 2 years and after large storm events</li> <li>○ Minimum of annually after that.</li> </ul> </li> </ul>
<b>Inspection records</b>	<ul style="list-style-type: none"> <li>• The owner will be responsible for keeping inspection records. The following items are recommended:             <ul style="list-style-type: none"> <li>○ Water elevations/observations (sheen, smell, etc)</li> <li>○ Condition of the inlet, outlet, storage manhole (if any) and overflow structures/devices, etc</li> <li>○ Condition of pre-treatment device (if any), sediment chamber/catchpit (if any)</li> <li>○ Unscheduled maintenance needs</li> <li>○ Components that require immediate maintenance</li> <li>○ Common problem areas, solutions, and general observations</li> <li>○ Aesthetic condition.</li> </ul> </li> </ul>

### (b) Sediment management/pollutant control:

Sediment and other pollutants that degrade water quality will accumulate in the soakage/groundwater recharge soakpit, sediment chamber/catchpit, storage manhole, and pre-treatment devices, and require removal to ensure proper operational performance. Corresponding requirements include:

- Remove sediment when accumulations reach 100 mm in depth or 50% of the designed sediment storage depth, or if sediment accumulation inhibits facility operation
- Dispose of the sediment in a safe manner
- If sediment and/or other pollutants are accumulating more rapidly than assumed when the O&M Plan was formulated, investigate, identify, and rectify the cause

- Refer to manufacturer's manual for proprietary devices.

**(c) Pre-treatment:**

Pre-treatment devices are structures that are designed to be installed upstream of soakage systems to remove contaminants, litter, and sediment from stormwater flows to protect the soakage device from clogging and the aquifer from contaminants.

- Any site runoff (from paved areas) feeding to the soakpit must first pass through a pre-treatment device. Refer to GD07 and drawings GD07-11 for pre-treatment options and examples
- All catchment from residential roof water shall discharge to a settlement chamber or catchpit prior to entry to the device. Leaf guards and first flush diverters should also be considered to avoid blockage of gutters and spouting prior to the settlement chamber/catchpit.

**(d) Access and safety:**

O&M programmes must provide for safe and efficient access to a facility. The following are general requirements; specific conditions may require site-specific modifications:

- Secure easements necessary to provide facility and maintenance access (if applicable)
- Use only suitably trained personnel to access confined spaces
- Maintain ingress/egress routes to design standards, in a manner that allows efficient maintenance of the facility
- Ensure that fencing is in good repair
- Use an approved traffic management plan for access to devices within the road corridor
- Rockbores, manholes, pre-treatment devices, and sediment chambers/catchpits are most effectively cleaned using vacuum-type systems avoiding the need for man entry
- All soakage devices (except rockbores) may eventually require excavation of soil or scoria/gravel layers so that repairs can be made
- Rockbores may require to be retired and replaced by new rockbores
- Access to the device should be at least 2 -3 m wide with no overhead structures (i.e., decks/pergolas), to enable entry of a small excavator
- Alternatively, a proven reserve soakage site with better access may be identified.



## Appendix C1.6 O&M specific maintenance requirements for rockbores

### Appendix C1.6.1 Description of a rockbore

Soakage into fractured rock is primarily achieved through rockbores. A rockbore device consists of a concrete manhole chamber with a concrete floor and one or more boreholes, drilled through the concrete floor and into the underlying rock aquifer. Water enters the rock aquifer directly through the base of the chamber.

<b>Operational points</b>	<ul style="list-style-type: none"> <li>• General guidance on maintenance for pre-treatment devices is provided in this document.</li> <li>• In some cases, additional maintenance (e.g., vegetation, filter media, etc) will be needed. This may be covered here by amending the generic requirements to suit the specific pre-treatment device or submitting a separate O&amp;M form in accordance with GD01.</li> <li>• Maintenance of any catchpits or stormwater pipes feeding to the pre-treatment device may be included in this form, or separately with the pre-treatment device.</li> <li>• The rockbore manhole should be empty during dry conditions as it is not used for detention purposes.</li> </ul>
<b>General O&amp;M needs</b>	<ul style="list-style-type: none"> <li>• Maintenance of flow through the inlet system, e.g., spouting, downpipe system, pipework etc.</li> <li>• Removal of accumulated sediment from the sediment chamber/catchpit (if any).</li> <li>• Check the pre-treatment devices condition (if any) in according to relevant guidance document, e.g., stormwater treatment devices in GD01.</li> <li>• For proprietary devices, refer to manufacturing manual.</li> <li>• Cleaning of the rockbore soakage surface.</li> <li>• Checking the soakage capacity of the borehole.</li> <li>• Check condition of filter cage.</li> </ul>

**Appendix C1.6.2 Rockbore operation and maintenance checklist**

Frequency				Action
* After first two years some frequencies revert to annually or less (as noted); change in frequency is indicated by arrows				
After Storm	Quarterly	Annually*	>1/year	
√	√ √ √ → √			<b>Pre-treatment device (if any):</b> <ul style="list-style-type: none"> <li>• Check for debris accumulation and blockages.</li> <li>• Check grates and/or lids securely fitted.</li> <li>• Check condition of pre-treatment device for damage or wear and tear.</li> </ul>
	√ → √ √			<b>Sediment chamber/catchpit (if any):</b> <ul style="list-style-type: none"> <li>• Check sediment level in sediment chamber/catchpit. Keep sediment depths &gt;100 mm below chamber or catchpit outlet.</li> <li>• Check lid/grate secure on chamber.</li> </ul>
√	√ √	√		<b>Inlet system (spouting, downpipes, pipework and etc):</b> <ul style="list-style-type: none"> <li>• Check for debris accumulation and blockages; repair or remove as needed.</li> <li>• Check that the overflow or first flush diverter (if any) is not obstructed.</li> <li>• Check pipework, spouting, etc is in good working order and carry out maintenance as necessary.</li> </ul>
√		√ √ √ √	√	<b>Rockbore and chamber:</b> <ul style="list-style-type: none"> <li>• Check chamber access is able to be opened, i.e., not sealed over, jammed with debris, etc and is still accessible.</li> <li>• Check step rungs in good condition.</li> <li>• Inspect concrete base of rockbore for cracking, seal if needed.</li> <li>• Check for blockages by inspecting rockbore after heavy rain to ensure it drains down within 72 hrs of storm event.</li> <li>• Carry out rockbore cleaning as required (at least every <b>4 years on commercial sites and in roads/carparks</b>, and <b>6 years on residential sites</b>) including:                             <ul style="list-style-type: none"> <li>○ Remove accumulated sediment and water (if any) from borehole using hydro-vac</li> <li>○ Once chamber is empty, hydro-blast to clean out borehole</li> <li>○ Use hydro-vac to remove sediment loosened by hydro-blasting</li> <li>○ Check and clean filter cage, sleeve, and fixings. Repair any damage or wear and tear.</li> </ul> </li> </ul>

## Appendix C1.7 O&M specific maintenance requirements for stormwater soakpits

### Appendix C1.7.1 Description of a soakpit

A stormwater soakpit is an on-site stormwater system that is designed to cater for design storms through infiltration. This device is generally used in permeable soil, e.g., volcanic soils with scoria lenses or similar permeable layers on top of fractured rock. Soakage can sometimes be viable in dune areas.

<b>Operational points</b>	<ul style="list-style-type: none"> <li>• General guidance on maintenance for pre-treatment devices is provided in this document.</li> <li>• In some cases, additional maintenance (e.g., vegetation, filter media, etc) will be needed. This may be covered here by amending the generic requirements to suit the specific pre-treatment device or submitting a separate O&amp;M form in accordance with GD01.</li> <li>• Maintenance of any catchpits or stormwater pipes feeding to the pre-treatment device may be included in this form, or separately with the pre-treatment device.</li> <li>• The soakpit should be empty 24 hours after a storm event. This can be checked by observing the water level in the main chamber.</li> <li>• Some devices also include an additional storage manhole for detention purpose.</li> <li>• If the area above the soakpit is boggy or unusually wet, this may indicate the device is clogged.</li> </ul>
<b>General O&amp;M needs</b>	<ul style="list-style-type: none"> <li>• Maintenance of flow through the inlet system, e.g., spouting, downpipe system, pipework etc.</li> <li>• Removal of accumulated sediment from the sediment chamber/catchpit (if any).</li> <li>• Pre-treatment devices condition (if any) in according to relevant guidance document, e.g., stormwater treatment devices in GD01 or manufacturing manual for proprietary devices.</li> <li>• Checking the soakage capacity of the soakpit.</li> <li>• Monitor observation well to ensure soakpit is not clogged.</li> </ul>

### Appendix C1.7.2 Soakpit operation and maintenance checklist

Frequency				Action
* After first two years some frequencies revert to annually or less (as noted); change in frequency is indicated by arrows				
After Storm	Quarterly	Annually*	>1/year	
√	√ √ √ → √			<b>Pre-treatment device (if any):</b> <ul style="list-style-type: none"> <li>• Check for debris accumulation and blockages.</li> <li>• Check grates and/or lids securely fitted.</li> <li>• Check condition of pre-treatment device for damage or wear and tear.</li> </ul>
	√ → √ √			<b>Sediment chamber/catchpit (if any):</b> <ul style="list-style-type: none"> <li>• Check sediment level in sediment chamber/catchpit. Keep sediment depths &gt;100 mm below chamber or catchpit outlet.</li> <li>• Check lid/grate secure on chamber.</li> </ul>
√	√ √	√		<b>Inlet system (spouting, downpipes, pipework and etc):</b> <ul style="list-style-type: none"> <li>• Check for debris accumulation and blockages; repair or remove as needed.</li> <li>• Check that the overflow or first flush diverter (if any) is not obstructed.</li> <li>• Check pipework, spouting, etc in good working order and carry out maintenance as necessary.</li> </ul>
√		√ √ √ √		<b>Soakpit with storage manhole (if included):</b> <ul style="list-style-type: none"> <li>• Check manhole lid is able to be opened, i.e., not sealed over, jammed with debris, etc and is still accessible.</li> <li>• Check step rungs in good condition.</li> <li>• Inspect concrete base of manhole for cracking, seal if needed.</li> <li>• Check water level in storage manhole following rainfall event. The soakpit should drain down within 24 hrs if the soakpit is not clogged. If water remains within the soakpit after this time: <ul style="list-style-type: none"> <li>○ Remove water and sediment using hydro-vac</li> <li>○ Backflush the perforated drainage pipes within the soakpit using hydro-blasting via the storage manhole</li> <li>○ Remove any debris or sediment</li> <li>○ Re-check device after heavy rain or by filling the soakpit manually to see whether the device now drains within 24 hrs</li> <li>○ Repeat the process if necessary. If the soakpit still does not drain down within the required time period, the soakpit may need to be excavated and reconstructed (or a new soakpit built).</li> </ul> </li> <li>• If there is no water within the storage manhole, check sediment depth is &lt;100 mm, otherwise remove using hydro-vac.</li> </ul>

Frequency				Action
* After first two years some frequencies revert to annually or less (as noted); change in frequency is indicated by arrows				
After Storm	Quarterly	Annually*	>1/year	
√		√		<p><b>Soakpit without storage manhole (observation well only):</b></p> <ul style="list-style-type: none"> <li>• Check water level in observation well following rainfall event. The soakpit should drain down within 24 hrs if the soakpit is not clogged. If water remains within the soakpit after this time, or sediment is visible in the observation well:                             <ul style="list-style-type: none"> <li>○ Remove water and sediment using hydro-vac</li> <li>○ Backflush the perforated drainage pipes within the soakpit using hydro-blasting via the observation well</li> <li>○ Remove any debris or sediment</li> <li>○ Re-check device after heavy rain or by filling the soakpit manually to see whether the device now drains within 24 hrs</li> <li>○ Repeat the process if necessary. If the soakpit still does not drain down within the required time period, the soakpit may need to be excavated and reconstructed (or a new soakpit built).</li> </ul> </li> </ul>

## Appendix C1.8 O&M Specific maintenance requirements for groundwater recharge into peat soil

### Appendix C1.8.1 Description of groundwater recharge into peat soil

The primary purpose of the groundwater recharge soakpit device is to avoid drawdown-induced settlement, particularly in areas with peat soil. Stormwater disposal is not the primary purpose. This device designed to retain the stormwater runoff through infiltration.

<b>Operational points</b>	<ul style="list-style-type: none"> <li>• General guidance on maintenance for pre-treatment devices is provided in this document.</li> <li>• In some cases, additional maintenance (e.g., vegetation, filter media, etc.) will be needed. This may be covered here by amending the generic requirements to suit the specific pre-treatment device or submitting a separate O&amp;M form in accordance with GD01.</li> <li>• Maintenance of any catchpits or stormwater pipes feeding to the pre-treatment device may be included in this form, or separately with the pre-treatment device.</li> <li>• The groundwater recharge should be empty 72 hours after a storm event. This can be checked by observing the water level in the observation well.</li> <li>• If the area above the soakpit is boggy or unusually wet, this may indicate the device is clogged.</li> </ul>
<b>General O&amp;M needs</b>	<ul style="list-style-type: none"> <li>• Maintenance of flow through the Inlet system, e.g., spouting, downpipe system, pipework etc.</li> <li>• Removal of accumulated sediment from the sediment chamber/catchpit (if any).</li> <li>• Pre-treatment devices condition (if any) in according to relevant guidance document, e.g., stormwater treatment devices in GD01 or manufacturing manual for proprietary devices.</li> <li>• Checking the soakage capacity of the recharge pit.</li> <li>• Monitor observation well to ensure recharge pit is not clogged.</li> </ul>

**Appendix C1.8.2 Recharge pit operation and maintenance checklist**

Frequency				Action
* After first two years some frequencies revert to annually or less (as noted); change in frequency is indicated by arrows				
After Storm	Quarterly	Annually*	>1/year	
√	√ √ √ →	√		<p><b>Pre-treatment device (if any):</b></p> <ul style="list-style-type: none"> <li>• Check for debris accumulation and blockages.</li> <li>• Check grates and/or lids securely fitted.</li> <li>• Check condition of pre-treatment device for damage or wear and tear.</li> </ul>
	√ →	√		<p><b>Sediment chamber/catchpit (if any):</b></p> <ul style="list-style-type: none"> <li>• Check sediment level in sediment chamber/catchpit. Keep sediment depths &gt;100 mm below chamber or catchpit outlet.</li> <li>• Check lid/grate is secure on chamber.</li> </ul>
√	√ √	√		<p><b>Inlet system (spouting, downpipes, pipework and etc):</b></p> <ul style="list-style-type: none"> <li>• Check for debris accumulation and blockages; repair or remove as needed.</li> <li>• Check that the overflow or first flush diverter (if any) is not obstructed.</li> <li>• Check pipework, spouting, etc is in good working order and carry out maintenance as necessary.</li> </ul>
√		√		<p><b>Recharge pit:</b></p> <ul style="list-style-type: none"> <li>• Check water level in observation well following rainfall event. The recharge pit should drain down within 24 hrs if it is not clogged. If water remains within the recharge pit after this time, or sediment is visible in the observation well:                             <ul style="list-style-type: none"> <li>○ Remove water and sediment using hydro-vac</li> <li>○ Backflush the perforated drainage pipes within the recharge pit using hydro-blasting via the observation well</li> <li>○ Remove any debris or sediment</li> <li>○ Re-check device after heavy rain or by filling the recharge pit manually to see whether the device now drains within 24 hrs</li> <li>○ Repeat the process if necessary. If the recharge pit still does not drain down within the required time period, the recharge pit may need to be excavated and reconstructed (or a new recharge pit built).</li> </ul> </li> </ul>

## Appendix D1.0 Drawings



**GENERAL NOTES:**

1. ALL DIMENSIONS ARE IN mm (UNLESS OTHERWISE SPECIFIED).

DRAWING INDEX	
DRAWING NUMBER	DRAWING TITLE
GD07_00	COVER PAGE AND DRAWING INDEX
GD07_01	TYPICAL ROCKBORE – FOR FRACTURED ROCK (SECTION)
GD07_02	TYPICAL ROCKBORE – FOR FRACTURED ROCK (PLAN)
GD07_03	TYPICAL ROCKBORE FILTER CAGE – FOR FRACTURED ROCK (DETAILS)
GD07_04	TYPICAL STORMWATER SOAKPIT (PLAN) – FOR PERMEABLE SOIL
GD07_05	TYPICAL STORMWATER SOAKPIT (SECTION) – FOR PERMEABLE SOIL
GD07_06	TYPICAL STORMWATER SOAKPIT WITH STORAGE MANHOLE (PLAN) – FOR PERMEABLE SOIL
GD07_07	TYPICAL STORMWATER SOAKPIT WITH STORAGE MANHOLE (SECTION A-A) – FOR PERMEABLE SOIL
GD07_08	TYPICAL GROUNDWATER RECHARGE SOAKPIT – FOR PEAT SOIL (PLAN)
GD07_09	TYPICAL GROUNDWATER RECHARGE SOAKPIT – FOR PEAT SOIL (SECTION A-A)
GD07_10	TYPICAL GROUNDWATER RECHARGE SOAKPIT – FOR PEAT SOIL (SECTION B-B)
GD07_11	EXAMPLES OF PRE-TREATMENT DEVICES – FOR HIGH CONTAMINANT GENERATING SOURCES (ROADS, CAR PARKS)



PLOT DATE 23/6/2021 11:05 am U:\C00\IES\ETS\2. DTG\3. Guidance docs\GD07 – Soakage\Drawings\CAD\GD07\_00.dwg

SOAKAGE GUIDELINE DOCUMENT  
STANDARD DETAILS  
REVISION: 0  
REV DATE: 21/06/2021  
CAD FILENAME: GD07\_00.DWG

**AUCKLAND COUNCIL**

STORMWATER SOAKAGE AND GROUNDWATER RECHARGE IN THE AUCKLAND REGION 2020/007

COVER PAGE AND DRAWING INDEX

ENVIRONMENTAL – SW	ORIGINAL SCALE	A3
	SCALE: N.T.S.	
	DRAWING SET	SHEET
	GD07	1 OF 1
	DRAWING No.	REV
	GD07_00	0

PLOT DATE 23/6/2021 11:05 am U:\G00\IES\ETS\2. DTG\3. Guidance docs\GD07 - Soakage\Drawings\CAD\GD07\_01.dwg

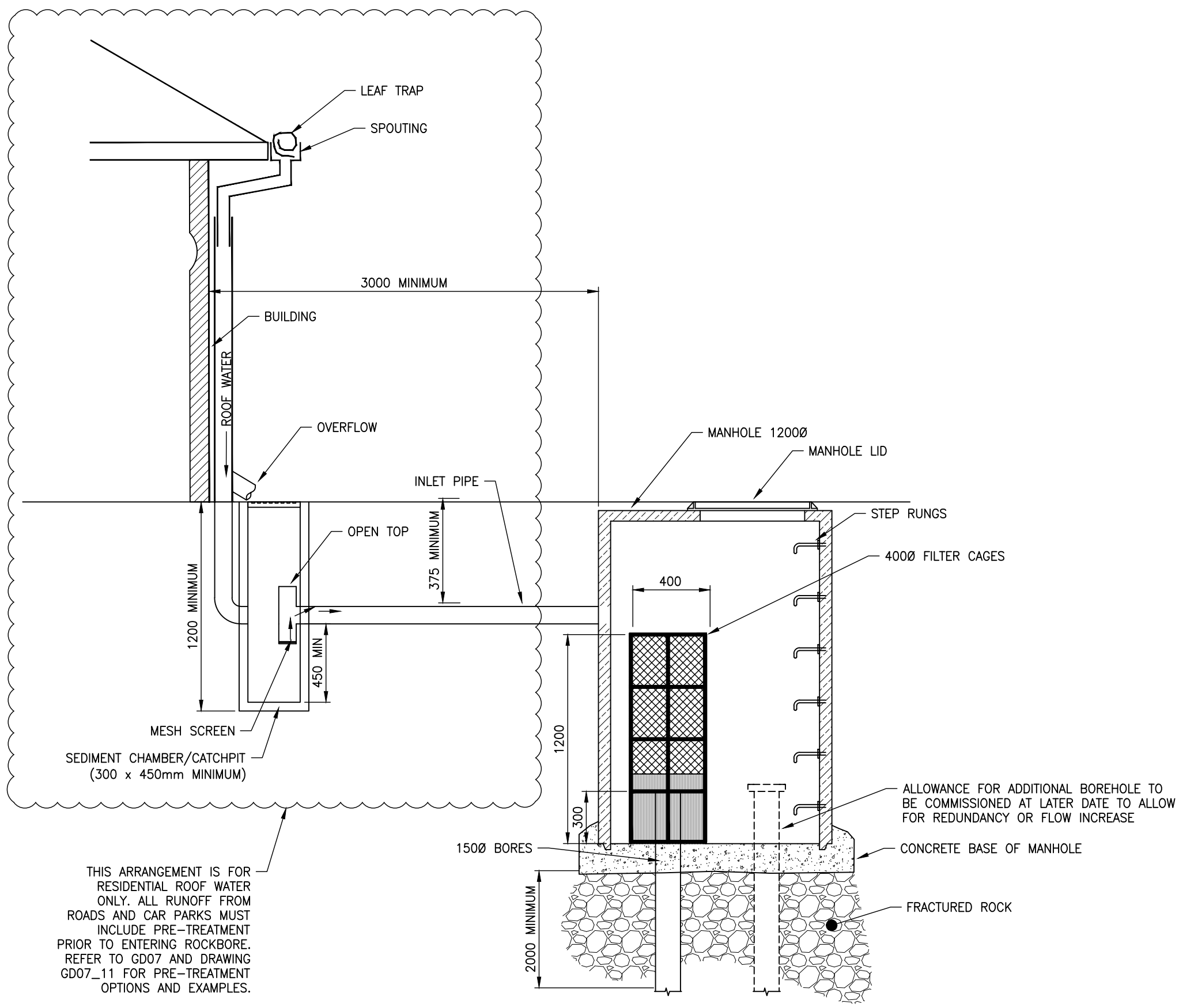

THIS ARRANGEMENT IS FOR RESIDENTIAL ROOF WATER ONLY. ALL RUNOFF FROM ROADS AND CAR PARKS MUST INCLUDE PRE-TREATMENT PRIOR TO ENTERING ROCKBORE. REFER TO GD07 AND DRAWING GD07\_11 FOR PRE-TREATMENT OPTIONS AND EXAMPLES.

**ROCKBORE WITH 1 BORE**

**NOTES:**

1. MINIMUM MANHOLE DIAMETER SIZED TO ACCOMODATE AN ADDITIONAL BOREHOLE TO BE COMMISSIONED AT A LATER DATE.
- | No. OF BORES | ALLOWANCE FOR ADDITIONAL BORES | MIN. MANHOLE DIAMETER FOR ROCKBORE |
|--------------|--------------------------------|------------------------------------|
| 1            | 1                              | 1200                               |
| 2            | 1                              | 1500                               |
| 3            | 1                              | 1800                               |
2. FLOW TESTING OF ROCKBORES TO BE CARRIED OUT BEFORE AND AFTER CAGE INSTALLATION.
  3. NEW ROCKBORE MINIMUM DEPTH OF MANHOLE 1.5m. MANHOLES DEEPER THAN 2.5m WILL NEED DISCUSSION AS ACCESSIBILITY FOR MAINTENANCE BECOMES AN ISSUE.
  4. MINIMUM DEPTH OF BOREHOLE FROM CONCRETE BASE OF MANHOLE IS 2.0m.
  5. ACCESS RUNGS SHALL BE PROVIDED FOR MANHOLE ACCESS. REFER TO DRAWING IN STORMWATER CODE OF PRACTICE FOR DETAILS.
  6. BOREHOLE POSITIONS RELATIVE TO MANHOLE LID NOT SHOWN TO ACCURATELY TO AID CLARITY. POSITION SHOULD BE AS PER DRAWING GD07\_02.
  7. SETBACK REQUIREMENTS  
BUILDINGS AND PROPERTY BOUNDARIES:
    - A SETBACK DISTANCE OF 3m IS RECOMMENDED FOR BUILDINGS AND PROPERTY BOUNDARIES. SPECIFIC GEOTECHNICAL DESIGN WILL BE REQUIRED WHERE THE DEVICE MAY AFFECT ADJACENT STRUCTURES (SUBJECT TO COUNCIL APPROVAL).
    - WHERE THIS IS NOT PRACTICALLY POSSIBLE A SITE-SPECIFIC GEOTECHNICAL DESIGN MUST BE COMPLETED TAKING INTO ACCOUNT THE EFFECTS OF THE SOAKAGE DEVICE ON BUILDING FOUNDATIONS AND POTENTIAL FOR FLOODING OF NEIGHBOURING PROPERTIES. THIS MUST BE DONE BY A CHARTERED GEOTECHNICAL ENGINEER OR A PROFESSIONAL ENGINEERING GEOLOGIST.
    - DEVICES SHALL NOT BE PLACED BELOW BUILDINGS AND BUILDINGS SHALL NOT BE BUILT OVER SOAKAGE DEVICES.
 RETAINING WALLS:
    - FOR WALLS < 2m HIGH, THE SETBACK MUST NOT BE LESS THAN THE HEIGHT OF THE RETAINING WALL + 1.5m AND WHERE THE SOAKAGE DEVICE IS UP SLOPE OF THE WALL, THEN THE WALL MUST HAVE BEEN DESIGNED TO TAKE FULL WATER LOADING.
    - THE ROCK BORE MUST BE DESIGNED TO DISCHARGE IN A ZONE THAT IS BELOW THE TOE OF ANY WALL WITHIN 10 M.
    - FOR WALLS > 2m HIGH, A SITE-SPECIFIC DESIGN MUST BE CARRIED OUT BY A GEOTECHNICAL ENGINEER, CONSIDERING RELEVANT GEOTECHNICAL ISSUES AND CUT-OFF DRAINAGE OF THE RETAINING WALL.
 UNDERGROUND INFRASTRUCTURE:
    - A SETBACK DISTANCE OF 2m IS REQUIRED FROM ANY EXISTING WATER AND WASTEWATER PIPES.
  8. DEVICES THAT WILL BE VESTED TO AUCKLAND TRANSPORT SHALL BE DESIGNED IN ACCORDANCE WITH THE AUCKLAND TRANSPORT CODE OF PRACTICE.
  9. PIPE EMBEDMENT DETAILS FOR PRIVATE DRAINAGE SHALL COMPLY WITH BUILDING CODE AS PER NZS 7643.
  10. PIPE EMBEDMENT DETAILS FOR THE PUBLIC DRAINAGE SHALL COMPLY WITH STORMWATER CODE OF PRACTICE (SWCOP) DRAWINGS.

**AUCKLAND COUNCIL**

**TYPICAL ROCKBORE  
FOR FRACTURED ROCK (SECTION)**

SOAKAGE GUIDELINE DOCUMENT  
STANDARD DETAILS  
REVISION: 0  
REV DATE: 21/06/2021  
CAD FILENAME: GD07\_01.DWG

ENVIRONMENTAL-SW		ORIGINAL SCALE	A3
		SCALE: N.T.S.	
Auckland Council		DRAWING SET	SHEET
		GD07	1 OF 1
		DRAWING No.	REV
		GD07_01	0

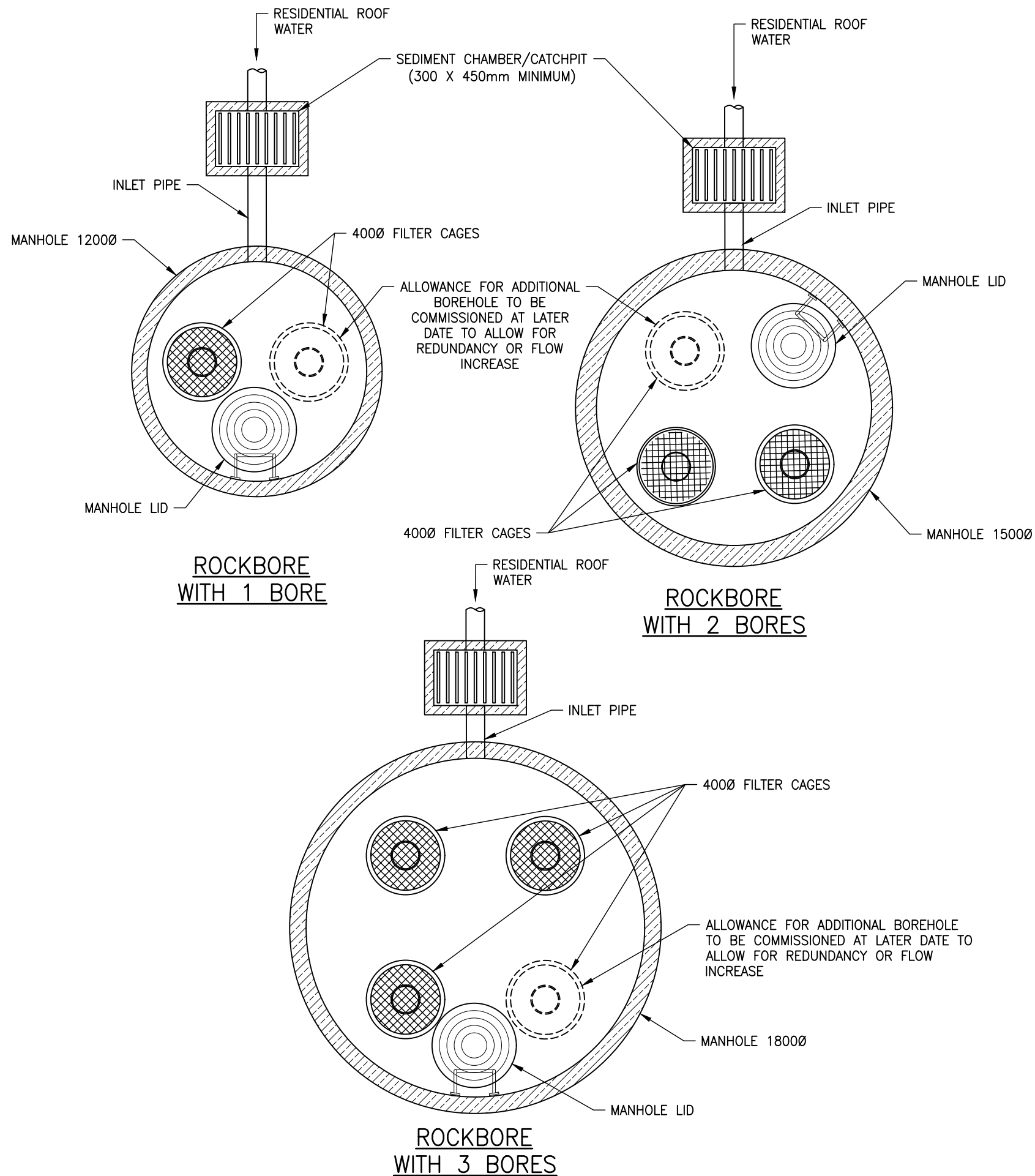

**NOTES:**

1. REFER TO DRAWING GD07\_01 NOTES 1.
2. ALLOWANCE SHALL BE MADE FOR 1 ADDITIONAL BORE TO BE DRILLED FOR REDUNDANCY DUE TO BLOCKAGE OR INCREASED FLOW.
3. ALL RESIDENTIAL ROOF WATER SHALL DISCHARGE TO SEDIMENT CHAMBER / CATCHPIT AND NOT DIRECTLY INTO THE DEVICE.
4. ALL RUNOFF FROM ROADS, CAR PARKS OR OTHER CONTAMINANT SOURCES MUST INCLUDE PRE-TREATMENT OF RUNOFF PRIOR TO ENTERING ROCKBORE. REFER TO GD07 AND DRAWING GD07\_11 FOR PRE-TREATMENT OPTIONS AND EXAMPLES.
5. LEAF TRAP TO BE INSTALLED IN ROOF GUTTERS.

PLOT DATE 23/6/2021 11:05 am U:\C00\IES\ETS\2. DTG\3. Guidance docs\GD07 - Soakage\Drawings\CAD\GD07\_02.dwg

SOAKAGE GUIDELINE DOCUMENT  
STANDARD DETAILS

REVISION: 0  
REV DATE: 21/06/2021  
CAD FILENAME: GD07\_02.DWG

**AUCKLAND COUNCIL**

**TYPICAL ROCKBORE  
FOR FRACTURED ROCK (PLAN)**

ENVIRONMENTAL-SW

ORIGINAL SCALE A3  
SCALE: N.T.S.

DRAWING SET SHEET

GD07 1 OF 1

DRAWING No. REV

GD07\_02 0



**NOTES:**

1. HOT DIP GALVANISE WHOLE CAGE AND SLEEVE AFTER FABRICATION. (APPROXIMATE WEIGHT OF WHOLE CAGE 16 TO 18kg)
2. RETROFIT TO EXISTING ROCKBORE: CAGE HEIGHT = MANHOLE DEPTH - 1.0m. MINIMUM CAGE HEIGHT TO BE 1.0m.

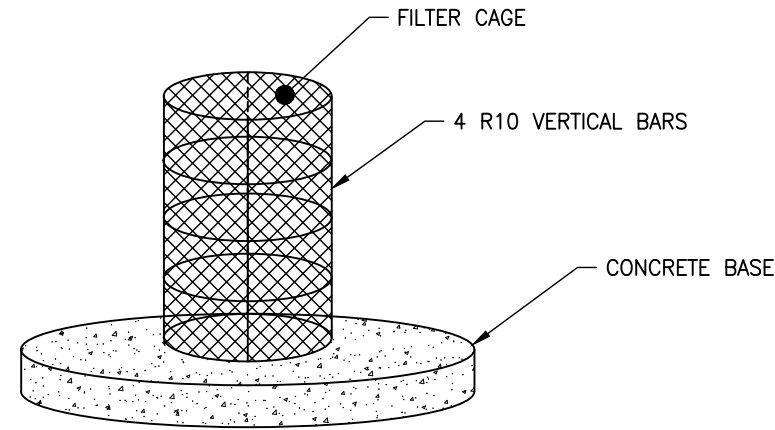

**CAGE 3D VIEW**

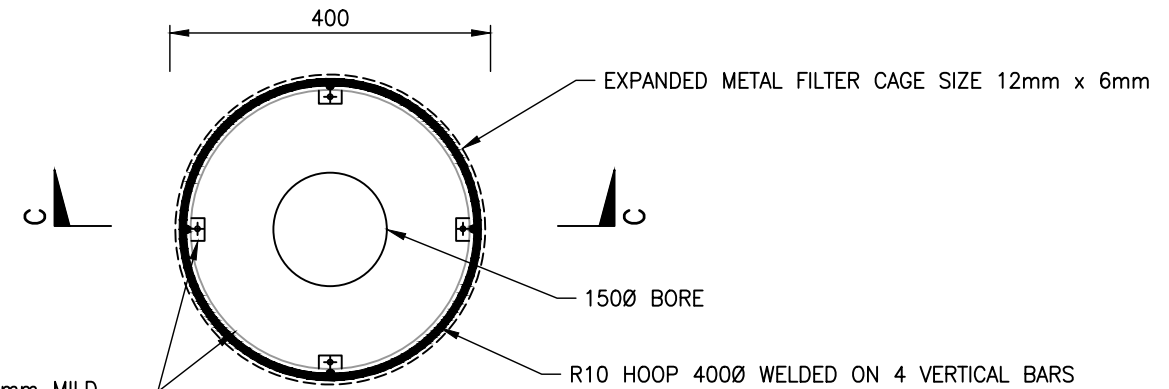

**SECTION B-B**

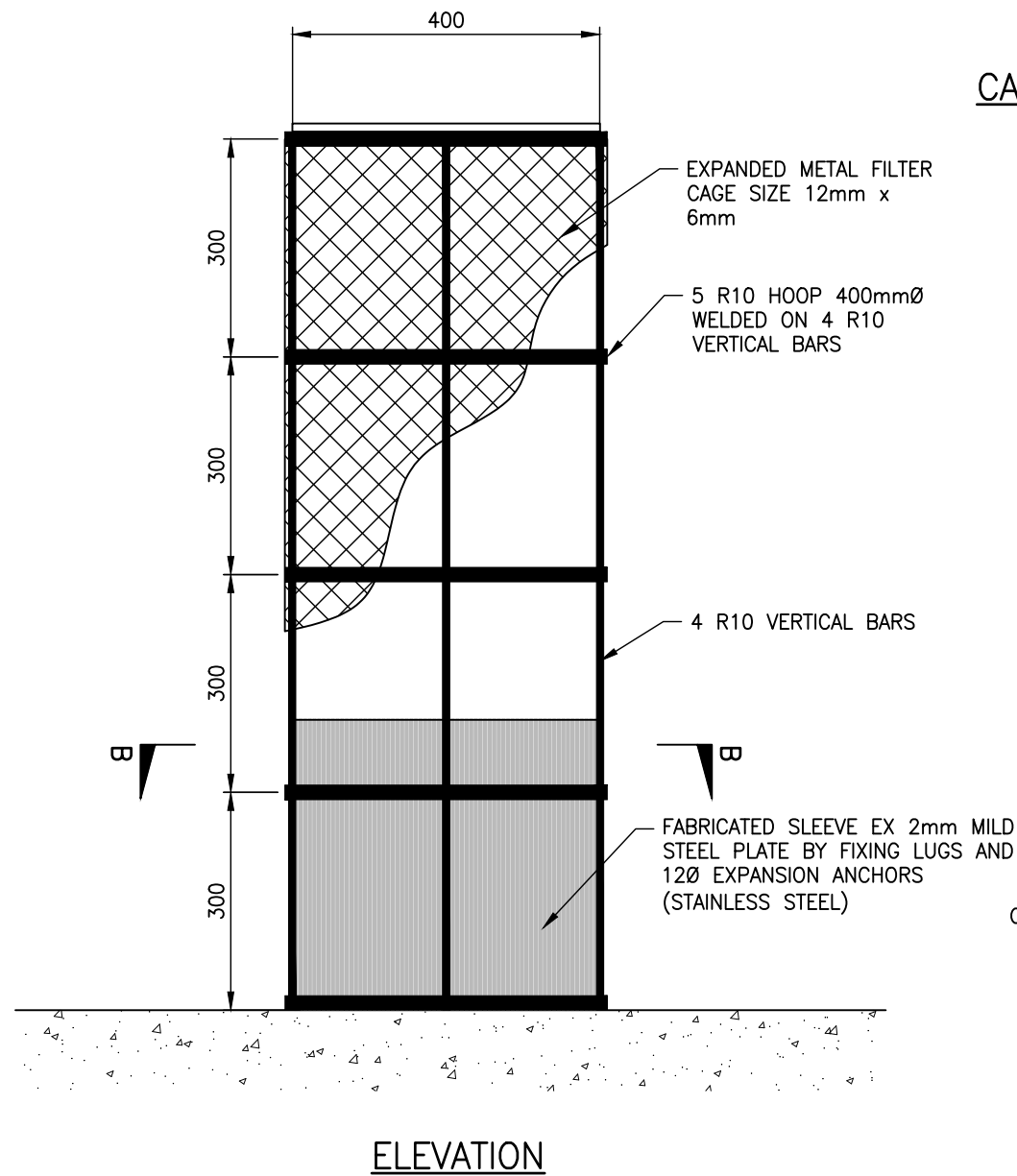

**ELEVATION**

FABRICATED SLEEVE EX 2mm MILD STEEL PLATE BY FIXING LUGS AND 12Ø EXPANSION ANCHORS (STAINLESS STEEL)

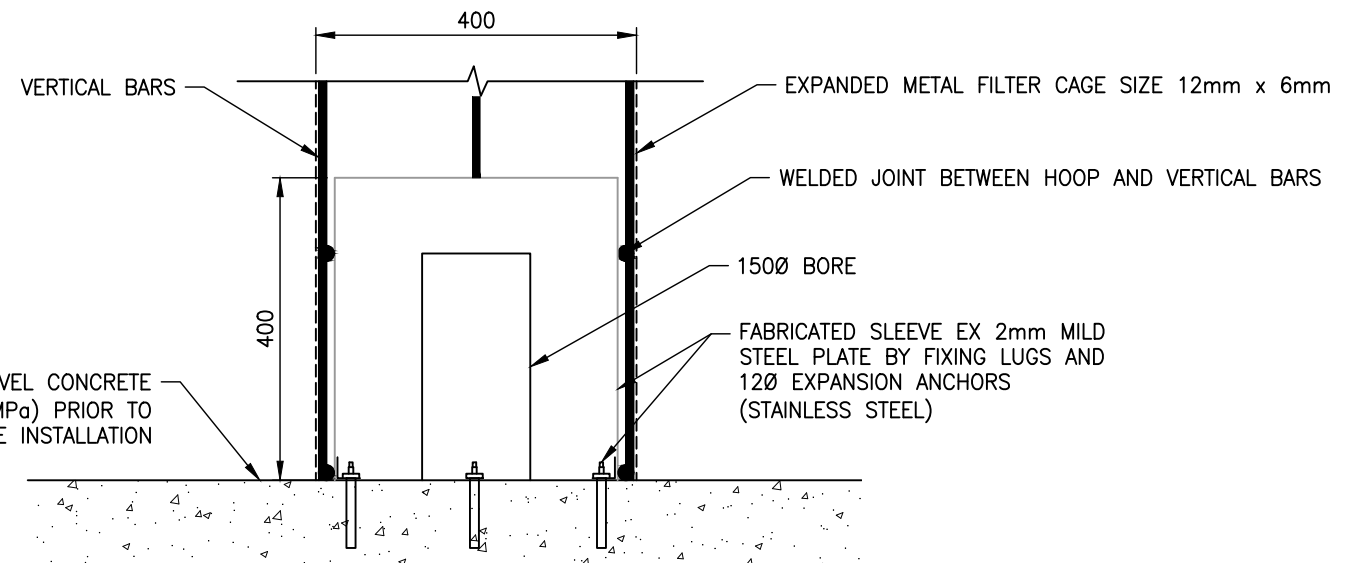

**SECTION C-C**

PLOT DATE 23/6/2021 11:05 am U:\G00\IES\ETS\2. DTG\3. Guidance docs\GD07 - Soakage\Drawings\CAD\GD07\_03.dwg

SOAKAGE GUIDELINE DOCUMENT  
STANDARD DETAILS  
REVISION: 0  
REV DATE: 21/06/2021  
CAD FILENAME: GD07\_03.DWG

**AUCKLAND COUNCIL**  
TYPICAL ROCKBORE FILTER CAGE (DETAILS)  
FOR FRACTURED ROCK

ENVIRONMENTAL-SW



ORIGINAL SCALE A3  
SCALE: N.T.S.

DRAWING SET SHEET

GD07 1 OF 1

DRAWING No. REV

GD07\_03 0



PLOT DATE 23/6/2021 11:05 am U:\C00\IES\ETS\2. DTG\3. Guidance docs\GD07 - Soakage\Drawings\CAD\GD07\_04.dwg

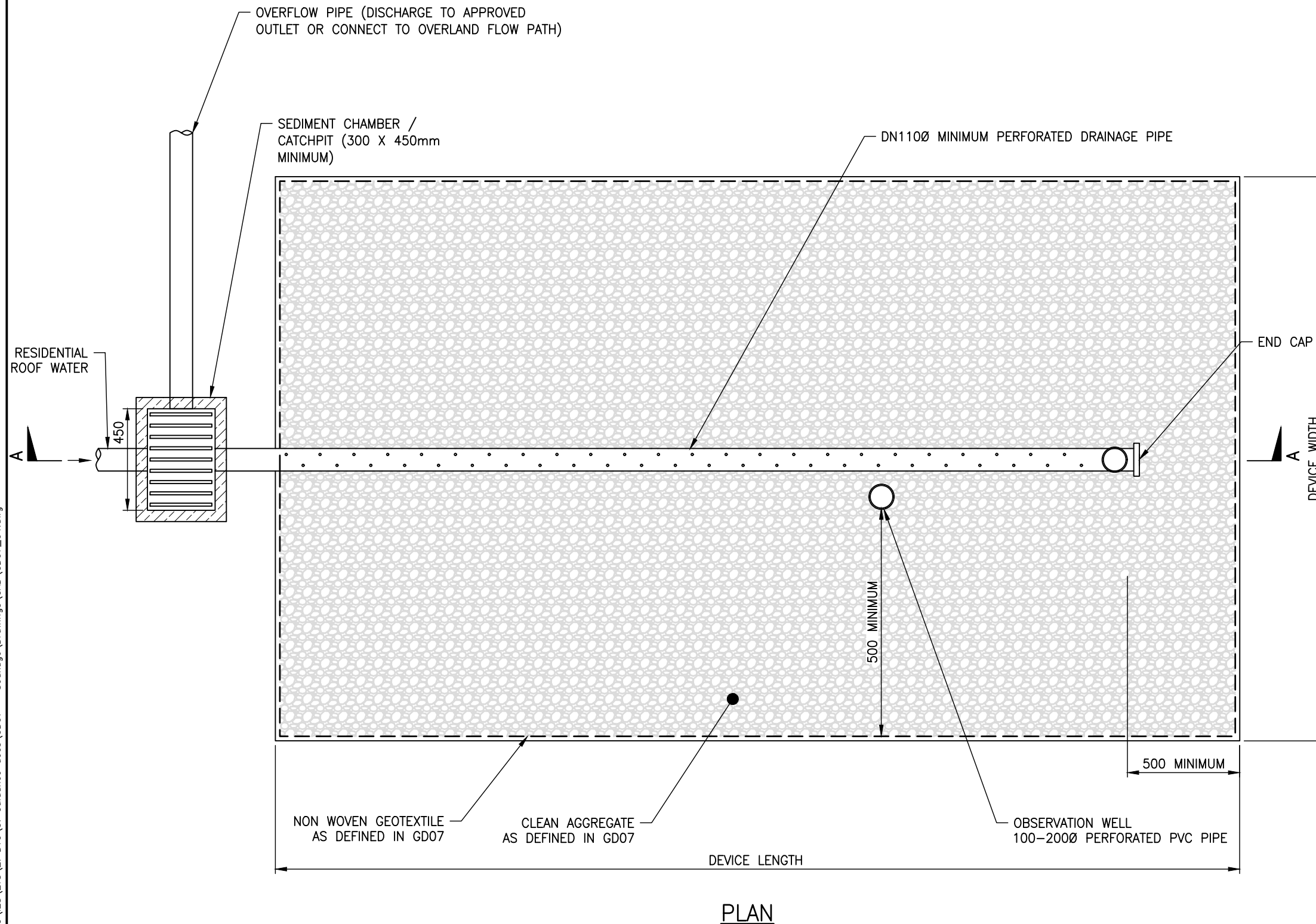

**NOTES:**

1. ALL DIMENSIONS ARE IN mm (UNLESS OTHERWISE SPECIFIED).
2. PRIVATE SW CONNECTION PIPES LAID WITH < 600mm COVER REQUIRE CONCRETE PROTECTION.
3. MANHOLE INSTALLATION AND SW CONNECTION TO THE PUBLIC SYSTEM AS PER THE RELEVANT PARTS OF THE AT/AC CODE.
4. LEAF TRAP TO BE INSTALLED IN ROOF GUTTERS.
5. ALL AGGREGATE INTERFACES TO BE LINED WITH NON WOVEN GEOTEXTILE.
6. DEVICE SHALL BE SIZED AND SPECIFIED AS PER GD2020/007.
7. ALL RESIDENTIAL ROOF WATER SHALL DISCHARGE TO SEDIMENT CHAMBER CATCHPIT AND NOT DIRECTLY TO THE DEVICE.
8. ALL RUNOFF FROM ROADS, CAR PARKS OR OTHER CONTAMINANT SOURCES MUST INCLUDE PRE-TREATMENT OF RUNOFF PRIOR TO ENTERING STORMWATER SOAKPIT. REFER TO GD07 AND DRAWING GD07\_11 FOR PRE-TREATMENT OPTIONS AND EXAMPLES.
9. SETBACK REQUIREMENTS
  - BUILDINGS AND PROPERTY BOUNDARIES:
    - A SETBACK DISTANCE OF 3m IS RECOMMENDED FOR BUILDINGS AND PROPERTY BOUNDARIES. SPECIFIC GEOTECHNICAL DESIGN WILL BE REQUIRED WHERE THE DEVICE MAY AFFECT ADJACENT STRUCTURES (SUBJECT TO COUNCIL APPROVAL).
    - WHERE THIS IS NOT PRACTICALLY POSSIBLE A SITE-SPECIFIC GEOTECHNICAL DESIGN MUST BE COMPLETED TAKING INTO ACCOUNT THE EFFECTS OF THE SOAKAGE DEVICE ON BUILDING FOUNDATIONS AND POTENTIAL FOR FLOODING OF NEIGHBOURING PROPERTIES. THIS MUST BE DONE BY A CHARTERED GEOTECHNICAL ENGINEER OR A PROFESSIONAL ENGINEERING GEOLOGIST.
    - DEVICES SHALL NOT BE PLACED BELOW BUILDINGS AND BUILDINGS SHALL NOT BE BUILT OVER SOAKAGE DEVICES.
  - RETAINING WALLS:
    - FOR WALLS < 2m HIGH:
      1. THE SETBACK MUST NOT BE LESS THAN THE HEIGHT OF THE RETAINING WALL + 1.5m.
      2. WHERE THE SOAKAGE DEVICE IS LESS THAN 10m UP-SLOPE OF THE WALL, THEN THE WALL MUST HAVE BEEN DESIGNED TO TAKE FULL WATER LOADING AND THE BASE OF THE SOAKAGE DEVICE SHOULD, WHERE POSSIBLE, BE AT AN ELEVATION BELOW THE TOE OF THE WALL.
    - FOR WALLS > 2m HIGH WITHIN 10m OF A SOAKAGE DEVICE, A SITE-SPECIFIC DESIGN MUST BE CARRIED OUT BY A GEOTECHNICAL ENGINEER, CONSIDERING RELEVANT GEOTECHNICAL ISSUES AND CUT-OFF DRAINAGE OF THE RETAINING WALL.
  - UNDERGROUND INFRASTRUCTURE:
    - A SETBACK DISTANCE OF 2m IS REQUIRED FROM ANY EXISTING WATER AND WASTEWATER PIPES.
10. PIPE EMBEDMENT DETAILS FOR PRIVATE DRAINAGE SHALL COMPLY WITH BUILDING CODE AS PER NZS 7643.
11. PIPE EMBEDMENT DETAILS FOR THE PUBLIC DRAINAGE SHALL COMPLY WITH STORMWATER CODE OF PRACTICE (SWCOP) DRAWINGS.
12. OBSERVATION WELL LOCATION IS INDICATIVE ONLY. MINIMUM OFFSET OF 500mm REQUIRED BETWEEN WELL EDGE AND DEVICE EDGE.

SOAKAGE GUIDELINE DOCUMENT  
STANDARD DETAILS  
REVISION: 0  
REV DATE: 21/06/2021  
CAD FILENAME: GD07\_04.DWG

**AUCKLAND COUNCIL**  
**TYPICAL STORMWATER SOAKPIT (PLAN)**  
FOR PERMEABLE SOIL

ENVIRONMENTAL-SW		ORIGINAL SCALE SCALE: N.T.S.	A3
		DRAWING SET GD07	SHEET 1 OF 1
		DRAWING No. GD07_04	REV 0

**NOTES:**

1. MAXIMUM DEPTH OF DEVICE IS 1500mm FROM SURFACE. ANY DEEPER DESIGN NEEDS A SPECIFIC DESIGN AND IS SUBJECT TO AUCKLAND COUNCIL APPROVAL.
2. PERFORATED DRAINAGE PIPE SHALL BE ACCESSIBLE FOR INSPECTION (I.E. CCTV) AND MAINTENANCE (I.E. WATER JET) VIA OBSERVATION WELL OR UPSTREAM SEDIMENT CHAMBER/CATCHPIT.
3. MINIMUM BEDDING DEPTH FOR DRAINAGE PIPE IS 300mm.
4. AT LEAST 500mm ABOVE THE SEASONAL HIGH GROUNDWATER LEVEL (WHERE THIS HAS BEEN MENTIONED OVER A FULL WINTER-SPRING SEASON WITH A PIEZOMETER OR SIMILAR TO GIVE A REASONABLE MEASUREMENT OF SEASONAL HIGH LEVEL) OR 1000mm ABOVE SEASONAL HIGH GROUNDWATER LEVEL WHERE THIS HAS NOT BEEN UNDERTAKEN.

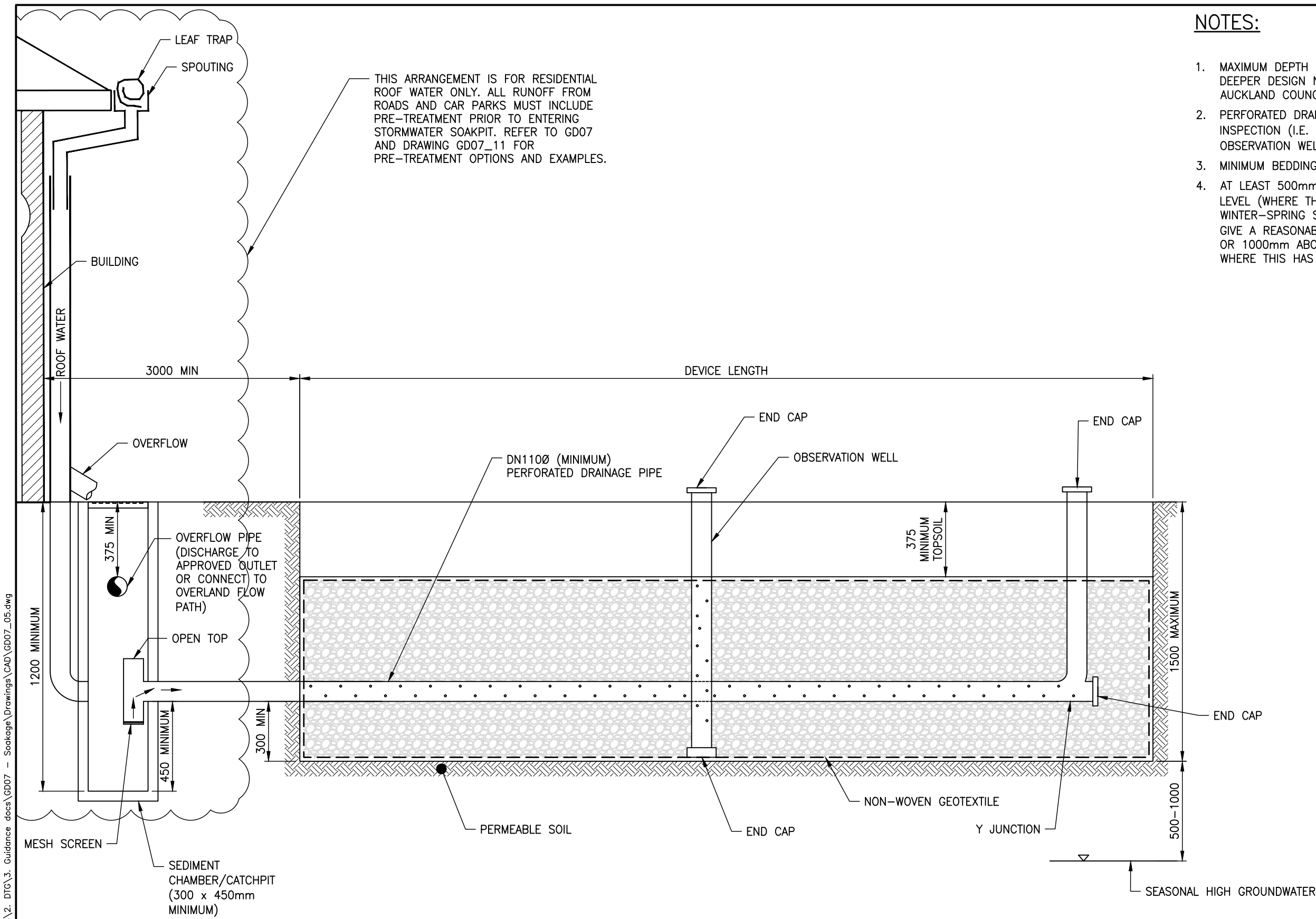

**SECTION A-A**

PLOT DATE 23/6/2021 11:05 am U:\C00\IES\ETS\2. DTG\3. Guidance docs\GD07 - Soakage\Drawings\CAD\GD07\_05.dwg

SOAKAGE GUIDELINE DOCUMENT STANDARD DETAILS  REVISION: 0 REV DATE: 21/06/2021 CAD FILENAME: GD07_05.DWG	<b>AUCKLAND COUNCIL</b> <b>TYPICAL STORMWATER SOAKPIT (SECTION)</b> <b>FOR PERMEABLE SOIL</b>		ENVIRONMENTAL-SW	ORIGINAL SCALE: A3 SCALE: N.T.S.
				DRAWING SET: GD07 SHEET: 1 OF 1 DRAWING No.: GD07_05 REV: 0

**NOTES:**

1. ALL DIMENSIONS ARE IN mm (UNLESS OTHERWISE SPECIFIED).
2. PRIVATE SW CONNECTION PIPES LAID WITH < 600mm COVER REQUIRE CONCRETE PROTECTION.
3. MANHOLE INSTALLATION AND SW CONNECTION TO THE PUBLIC SYSTEM AS PER THE RELEVANT PARTS OF THE AT/AC CODE.
4. LEAF TRAP TO BE INSTALLED IN ROOF GUTTERS.
5. ALL AGGREGATE INTERFACES TO BE LINED WITH NON WOVEN GEOTEXTILE.
6. 200 Holes in MH Chamber to be drilled at 300mm HORIZONTAL SPACING AND 150mm VERTICAL SPACING.
7. DEVICE SHALL BE SIZED AND SPECIFIED AS PER GD2020/007.
8. ALL RESIDENTIAL ROOF WATER SHALL DISCHARGE TO SEDIMENT CHAMBER/CATCHPIT AND NOT DIRECTLY TO THE DEVICE.
9. ALL RUNOFF FROM ROADS, CAR PARKS OR OTHER CONTAMINANT SOURCES MUST INCLUDE PRE-TREATMENT OF RUNOFF PRIOR TO ENTERING STORMWATER SOAKPIT. REFER TO GD07 AND DRAWING GD07\_11 FOR PRE-TREATMENT OPTIONS AND EXAMPLES.
10. SETBACK REQUIREMENTS

**BUILDINGS AND PROPERTY BOUNDARIES:**

- A SETBACK DISTANCE OF 3m IS RECOMMENDED FOR BUILDINGS AND PROPERTY BOUNDARIES. SPECIFIC GEOTECHNICAL DESIGN WILL BE REQUIRED WHERE THE DEVICE MAY AFFECT ADJACENT STRUCTURES (SUBJECT TO COUNCIL APPROVAL).
- WHERE THIS IS NOT PRACTICALLY POSSIBLE A SITE-SPECIFIC GEOTECHNICAL DESIGN MUST BE COMPLETED TAKING INTO ACCOUNT THE EFFECTS OF THE SOAKAGE DEVICE ON BUILDING FOUNDATIONS AND POTENTIAL FOR FLOODING OF NEIGHBOURING PROPERTIES. THIS MUST BE DONE BY A CHARTERED GEOTECHNICAL ENGINEER OR A PROFESSIONAL ENGINEERING GEOLOGIST.
- DEVICES SHALL NOT BE PLACED BELOW BUILDINGS AND BUILDINGS SHALL NOT BE BUILT OVER SOAKAGE DEVICES.

**RETAINING WALLS:**

- FOR WALLS < 2m HIGH:
  1. THE SETBACK MUST NOT BE LESS THAN THE HEIGHT OF THE RETAINING WALL + 1.5m
  2. WHERE THE SOAKAGE DEVICE IS LESS THAN 10m UP-SLOPE OF THE WALL, THEN THE WALL MUST HAVE BEEN DESIGNED TO TAKE FULL WATER LOADING AND THE BASE OF THE SOAKAGE DEVICE SHOULD, WHERE POSSIBLE, BE AT AN ELEVATION BELOW THE TOE OF THE WALL.
- FOR WALLS > 2m, A SITE SPECIFIC DESIGN MUST BE CARRIED OUT BY A GEOTECHNICAL ENGINEER, CONSIDERING RELEVANT GEOTECHNICAL ISSUES AND CUT-OFF DRAINAGE OF THE RETAINING WALL.

**UNDERGROUND INFRASTRUCTURE:**

- A SETBACK DISTANCE OF 2m IS REQUIRED FROM ANY EXISTING WATER AND WASTEWATER PIPES.

11. PIPE EMBEDMENT DETAILS FOR PRIVATE DRAINAGE SHALL COMPLY WITH BUILDING CODE AS PER NZS 7643.
12. PIPE EMBEDMENT DETAILS FOR THE PUBLIC DRAINAGE SHALL COMPLY WITH STORMWATER CODE OF PRACTICE (SWCOP) DRAWINGS.

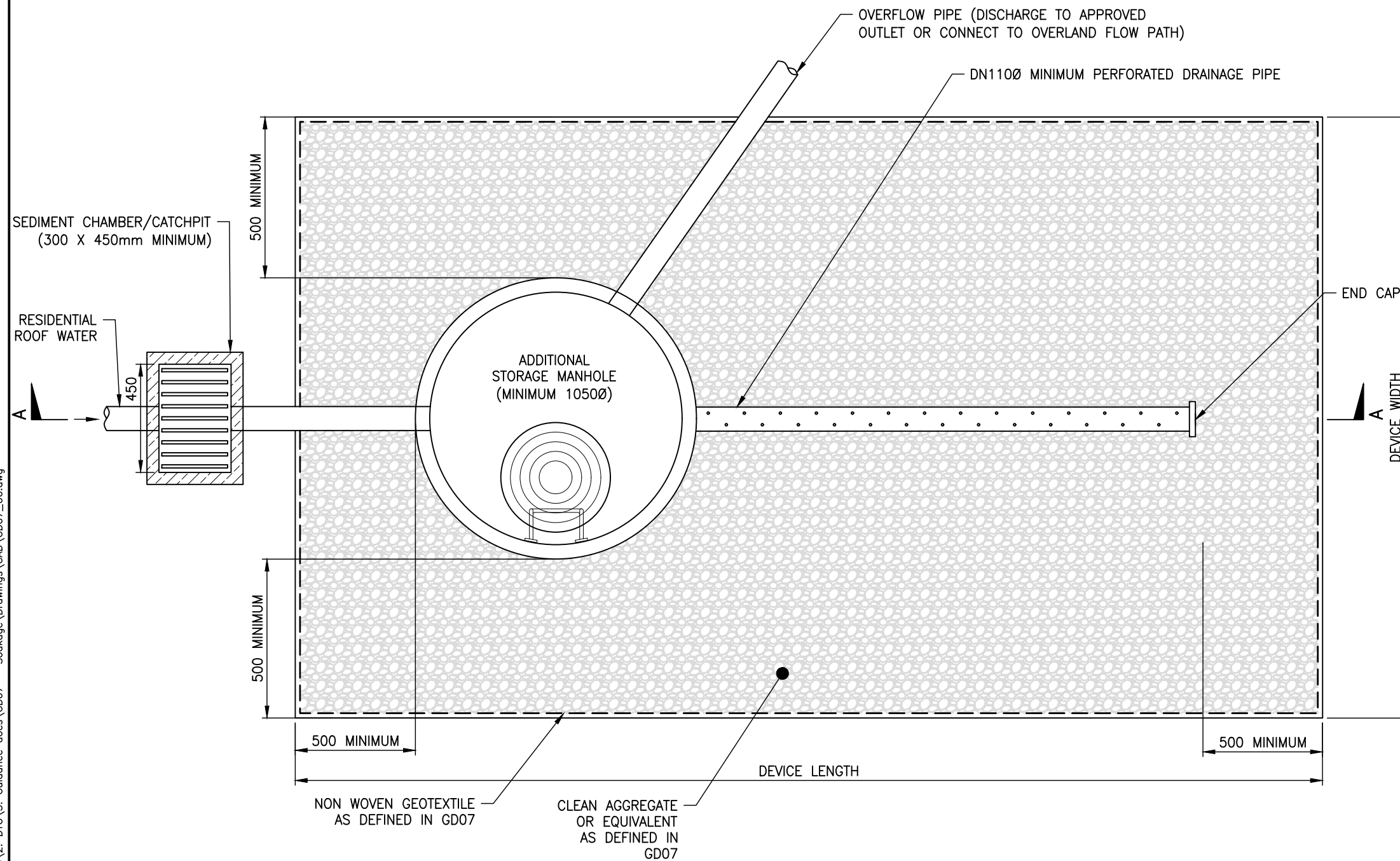

**PLAN**

PLOT DATE 23/6/2021 11:06 am U:\C00\IES\ETS\2. DTG\3. Guidance docs\GD07 - Soakage\Drawings\CAD\GD07\_06.dwg

SOAKAGE GUIDELINE DOCUMENT STANDARD DETAILS
REVISION: 0
REV DATE: 21/06/2021
CAD FILENAME: GD07_06.DWG

**AUCKLAND COUNCIL**

**TYPICAL STORMWATER SOAKPIT WITH STORAGE MANHOLE (PLAN)**

FOR PERMEABLE SOIL

ENVIRONMENTAL-SW	ORIGINAL SCALE SCALE: N.T.S.	A3
	DRAWING SET	SHEET
	GD07	1 OF 1
DRAWING No.	REV	
GD07_06	0	



**NOTES:**

1. MAXIMUM DEPTH OF DEVICE IS 1500mm FROM SURFACE. ANY DEEPER DESIGN NEEDS A SPECIFIC DESIGN AND IS SUBJECT TO AUCKLAND COUNCIL APPROVAL.
2. MINIMUM BEDDING DEPTH FOR THE DRAINAGE PIPE IS 300mm.
3. AT LEAST 500mm ABOVE THE SEASONAL HIGH GROUNDWATER LEVEL (WHERE THIS HAS BEEN MENTIONED OVER A FULL WINTER-SPRING SEASON WITH A PIEZOMETER OR SIMILAR TO GIVE A REASONABLE MEASUREMENT OF SEASONAL HIGH LEVEL) OR 1000mm ABOVE SEASONAL HIGH GROUNDWATER LEVEL WHERE THIS HAS NOT BEEN UNDERTAKEN.

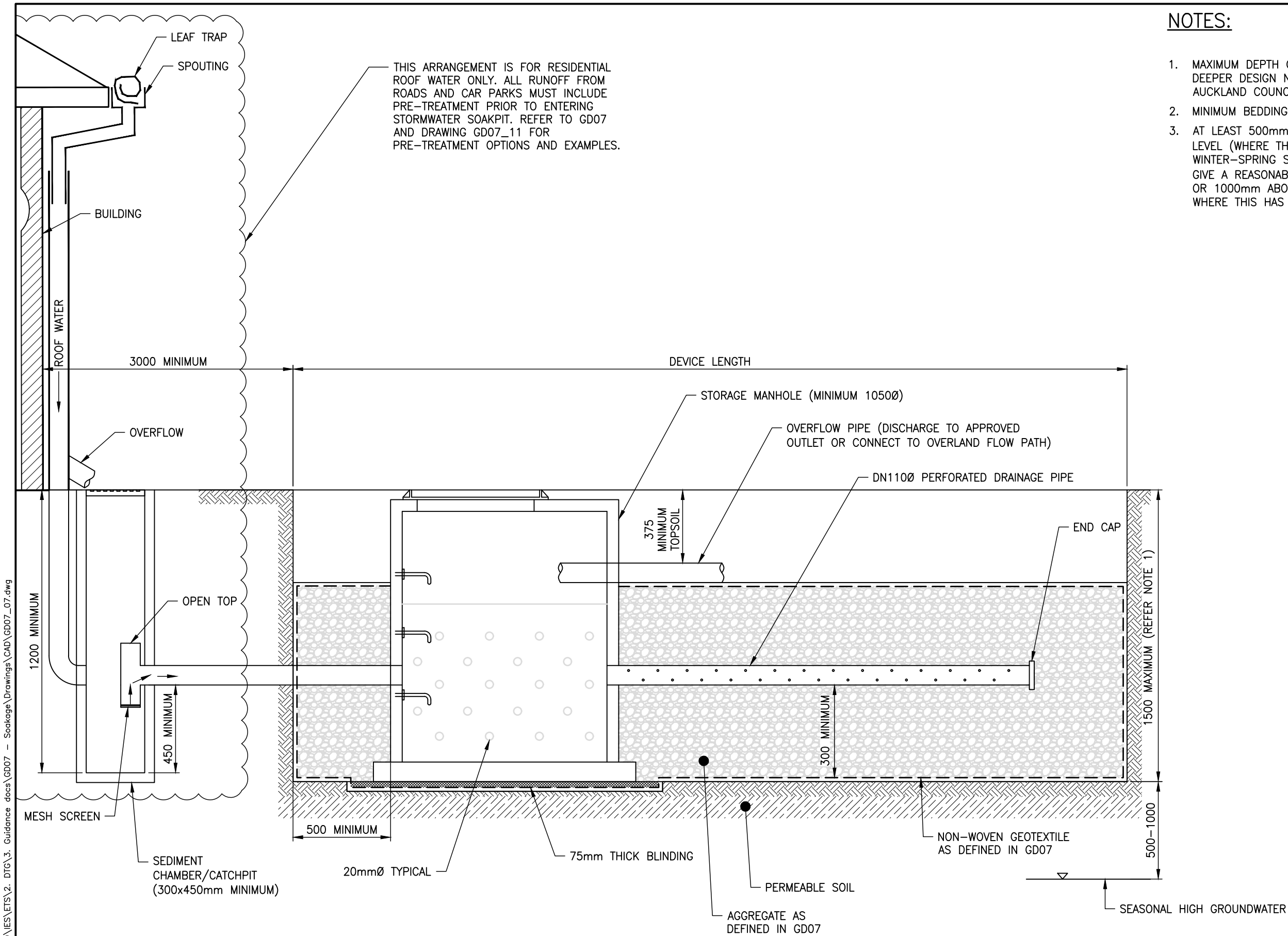

**SECTION A-A**

PLOT DATE 23/6/2021 11:06 am U:\G00\IES\ETS\2. DTG\3. Guidance docs\GD07 - Soakage\Drawings\CAD\GD07\_07.dwg

SOAKAGE GUIDELINE DOCUMENT  
STANDARD DETAILS  
REVISION: 0  
REV DATE: 21/06/2021  
CAD FILENAME: GD07\_07.DWG

**AUCKLAND COUNCIL**

**TYPICAL STORMWATER SOAKPIT WITH ADDITIONAL STORAGE MANHOLE (SECTION)  
FOR PERMEABLE SOIL**

	ENVIRONMENTAL-SW	ORIGINAL SCALE	A3
		SCALE: N.T.S.	
	DRAWING SET	SHEET	
	GD07	1 OF 1	
	DRAWING No.	REV	
	GD07_07	0	



**NOTES:**

1. ALL DIMENSIONS ARE IN mm (UNLESS OTHERWISE SPECIFIED).
2. PRIVATE SW CONNECTION PIPES LAID WITH < 600mm COVER REQUIRE CONCRETE PROTECTION.
3. MANHOLE INSTALLATION AND SW CONNECTION TO THE PUBLIC SYSTEM AS PER THE RELEVANT PARTS OF THE AT/AC CODE.
4. LEAF TRAP TO BE INSTALLED IN ROOF GUTTERS.
5. ALL AGGREGATE INTERFACES TO BE LINED WITH NON WOVEN GEOTEXTILE.
6. DEVICE SHALL BE SIZED AND SPECIFIED AS PER GD2020/007.
7. ALL RESIDENTIAL ROOF WATER SHALL DISCHARGE TO SEDIMENT CHAMBER/CATCHPIT AND NOT DIRECTLY TO THE DEVICE.
8. ALL RUNOFF FROM ROADS, CAR PARKS OR OTHER CONTAMINANT SOURCES MUST INCLUDE PRE-TREATMENT OF RUNOFF PRIOR TO ENTERING GROUNDWATER RECHARGE PIT. REFER TO GD07 AND DRAWING GD07\_11 FOR PRE-TREATMENT OPTIONS AND EXAMPLES.
9. SETBACK REQUIREMENTS  
BUILDINGS AND PROPERTY BOUNDARIES:
  - A SETBACK DISTANCE OF 3m IS RECOMMENDED FOR BUILDINGS AND PROPERTY BOUNDARIES. SPECIFIC GEOTECHNICAL DESIGN WILL BE REQUIRED WHERE THE DEVICE MAY AFFECT ADJACENT STRUCTURES (SUBJECT TO COUNCIL APPROVAL).
  - WHERE THIS IS NOT PRACTICALLY POSSIBLE A SITE-SPECIFIC GEOTECHNICAL DESIGN MUST BE COMPLETED TAKING INTO ACCOUNT THE EFFECTS OF THE SOAKAGE DEVICE ON BUILDING FOUNDATIONS AND POTENTIAL FOR FLOODING OF NEIGHBOURING PROPERTIES. THIS MUST BE DONE BY A CHARTERED GEOTECHNICAL ENGINEER OR A PROFESSIONAL ENGINEERING GEOLOGIST.
  - DEVICES SHALL NOT BE PLACED BELOW BUILDINGS AND BUILDINGS SHALL NOT BE BUILT OVER SOAKAGE DEVICES.
- RETAINING WALLS:
  - FOR WALLS < 2m HIGH, THE SETBACK MUST NOT BE LESS THAN THE HEIGHT OF THE RETAINING WALL + 1.5m AND WHERE THE SOAKAGE DEVICE IS UP-SLOPE OF THE WALL THEN THE WALL MUST HAVE BEEN DESIGNED TO TAKE FULL WATER LOADING.
  - FOR WALLS > 2m, A SITE-SPECIFIC DESIGN MUST BE CARRIED OUT BY A GEOTECHNICAL ENGINEER, CONSIDERING RELEVANT GEOTECHNICAL ISSUES AND CUT-OFF DRAINAGE OF THE RETAINING WALL.
- UNDERGROUND INFRASTRUCTURE:
  - A SETBACK DISTANCE OF 2m IS REQUIRED FROM ANY EXISTING WATER AND WASTEWATER PIPES.
10. PIPE EMBEDMENT DETAILS FOR PRIVATE DRAINAGE SHALL COMPLY WITH BUILDING CODE AS PER NZS 7643.
11. PIPE EMBEDMENT DETAILS FOR THE PUBLIC DRAINAGE SHALL COMPLY WITH STORMWATER CODE OF PRACTICE (SWCOP) DRAWINGS.

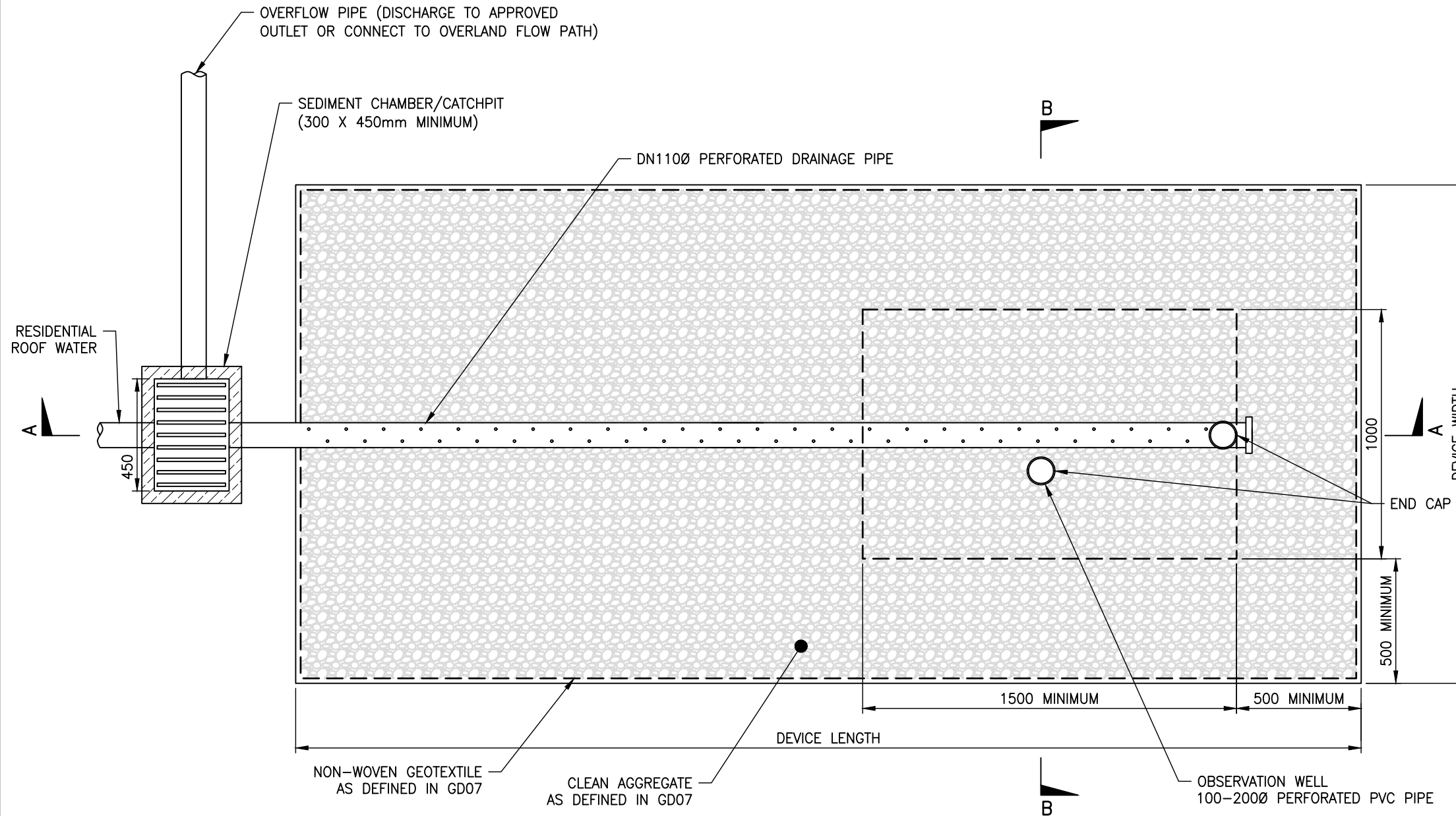

**PLAN**

PLOT DATE 23/6/2021 11:06 am U:\C00\IES\ETS\2. DTG\3. Guidance docs\GD07 - Soakage\Drawings\CAD\GD07\_08.dwg

SOAKAGE GUIDELINE DOCUMENT  
STANDARD DETAILS  
REVISION: 0  
REV DATE: 21/06/2021  
CAD FILENAME: GD07\_08.DWG

**AUCKLAND COUNCIL**  
**TYPICAL GROUNDWATER RECHARGE SOAKPIT (PLAN)**  
**FOR PEAT SOIL**

ENVIRONMENTAL-SW		ORIGINAL SCALE	A3
		SCALE: N.T.S.	
Auckland Council <small>Te Kaitiaki o Tāmaki Makaurau</small>		DRAWING SET	SHEET
		GD07	1 OF 1
		DRAWING No.	REV
		GD07_08	0

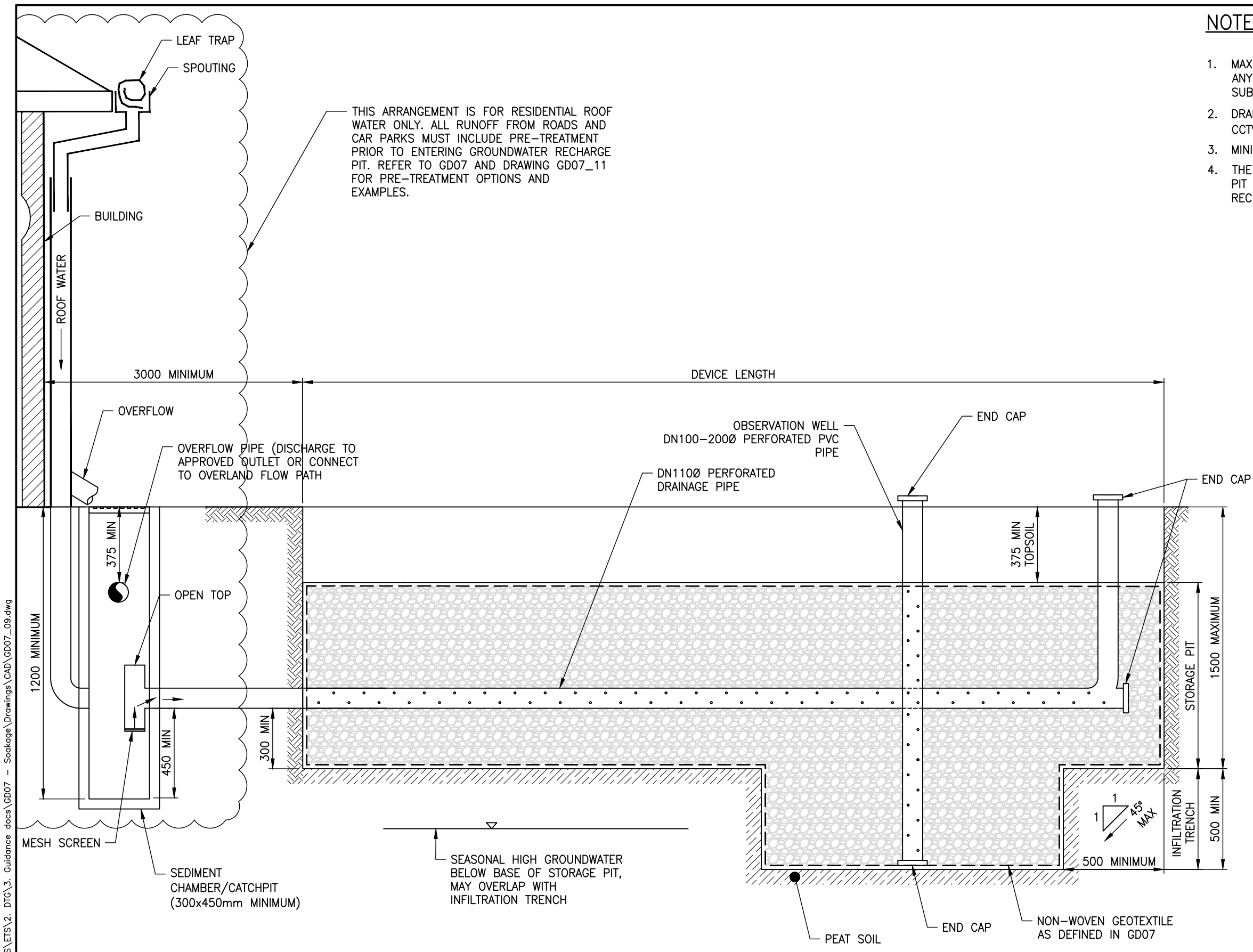

- NOTES:**
1. MAXIMUM DEPTH OF STORAGE PIT IS 1500mm FROM SURFACE. ANY DEEPER DESIGN NEEDS A SPECIFIC DESIGN AND IS SUBJECT TO AUCKLAND COUNCIL APPROVAL.
  2. DRAINAGE PIPE SHALL BE ACCESSIBLE FOR INSPECTION (I.E. CCTV) AND MAINTENANCE (I.E. WATER JET).
  3. MINIMUM BEDDING DEPTH FOR DRAINAGE PIPE IS 300mm.
  4. THE OFFSET FROM STORAGE PIT TO GROUNDWATER RECHARGE PIT SHALL BE 500mm MINIMUM. THE DEPTH OF GROUNDWATER RECHARGE PIT SHALL BE THE SAME DIMENSION.

**SECTION A-A**

PLOT DATE 23/6/2021 11:06 am U:\G00\IES\ETS\2. DTG\3. Guidance docs\GD07 - Soakage\Drawings\CAD\GD07\_09.dwg

SOAKAGE GUIDELINE DOCUMENT  
STANDARD DETAILS

REVISION: 0  
REV DATE: 21/06/2021  
CAD FILENAME: GD07\_09.DWG

**AUCKLAND COUNCIL**

**TYPICAL GROUNDWATER RECHARGE SOAKPIT (SECTION)**

**FOR PEAT SOIL**

	ENVIRONMENTAL-SW	ORIGINAL SCALE	A3
		SCALE: N.T.S.	
	DRAWING SET	SHEET	
	GD07	1 OF 1	
	DRAWING No.	REV	
	GD07_09	0	

**NOTES:**

1. THE OFFSET FROM STORAGE PIT TO GROUNDWATER RECHARGE PIT SHALL BE 500mm MINIMUM. THE DEPTH OF GROUNDWATER RECHARGE PIT SHALL BE THE SAME DIMENSION.

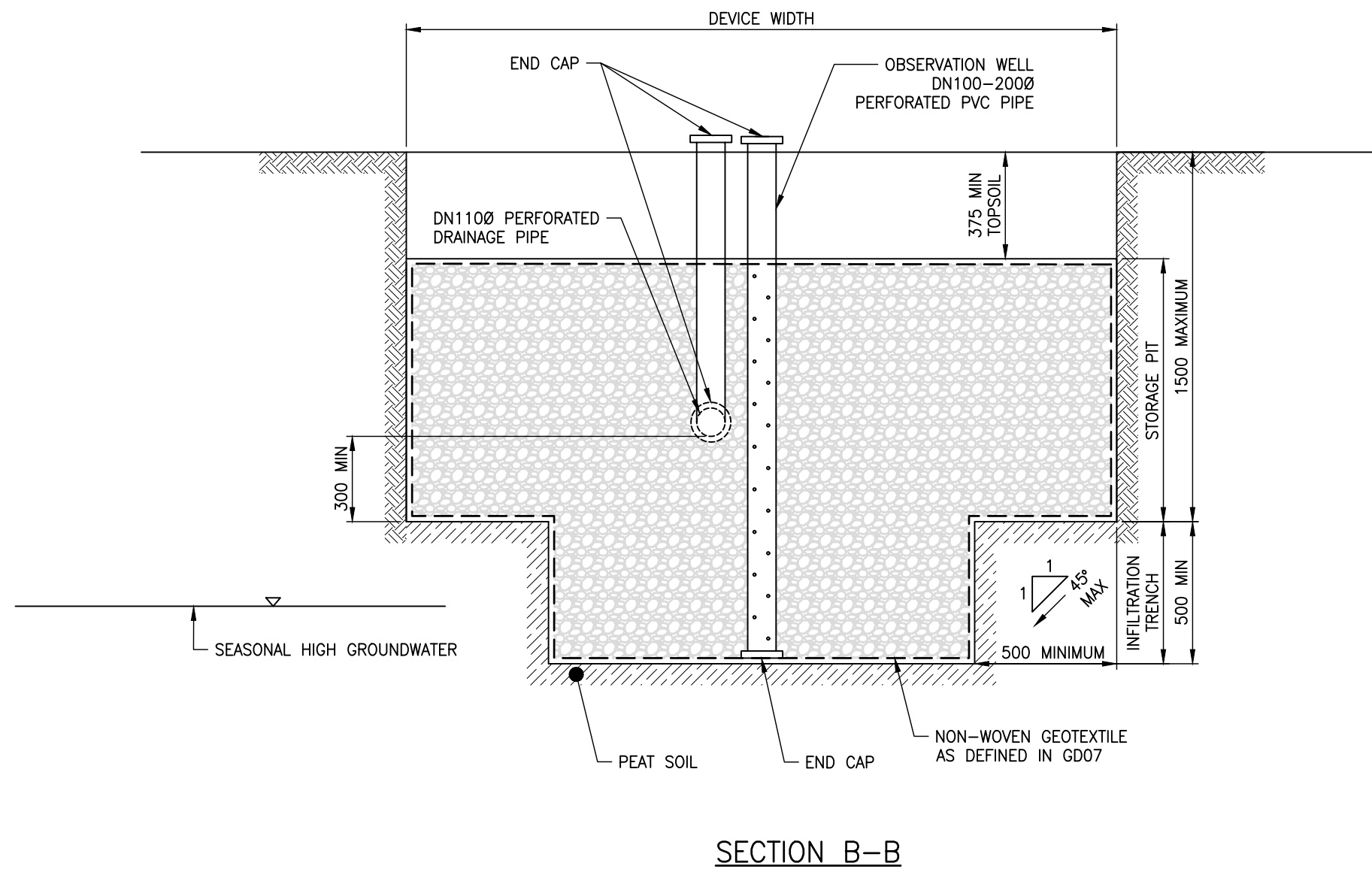

PLOT DATE 23/6/2021 11:06 am U:\G00\IES\ETS\2. DTG\3. Guidance docs\GD07 - Soakage\Drawings\CAD\GD07\_10.dwg

SOAKAGE GUIDELINE DOCUMENT  
STANDARD DETAILS  
REVISION: 0  
REV DATE: 21/06/2021  
CAD FILENAME: GD07\_10.DWG

**AUCKLAND COUNCIL**  
TYPICAL GROUNDWATER RECHARGE SOAKPIT (SECTION)  
FOR PEAT SOIL

ENVIRONMENTAL-SW

ORIGINAL SCALE A3  
SCALE: N.T.S.



DRAWING SET SHEET

GD07 1 OF 1

DRAWING No. REV

GD07\_10 0

**NOTES:**

1. STORMWATER TREATMENT DEVICES SHALL BE SIZED AND SPECIFIED AS PER GD01.
2. REFER TO GD07 FOR OTHER PRE-TREATMENT OPTIONS.

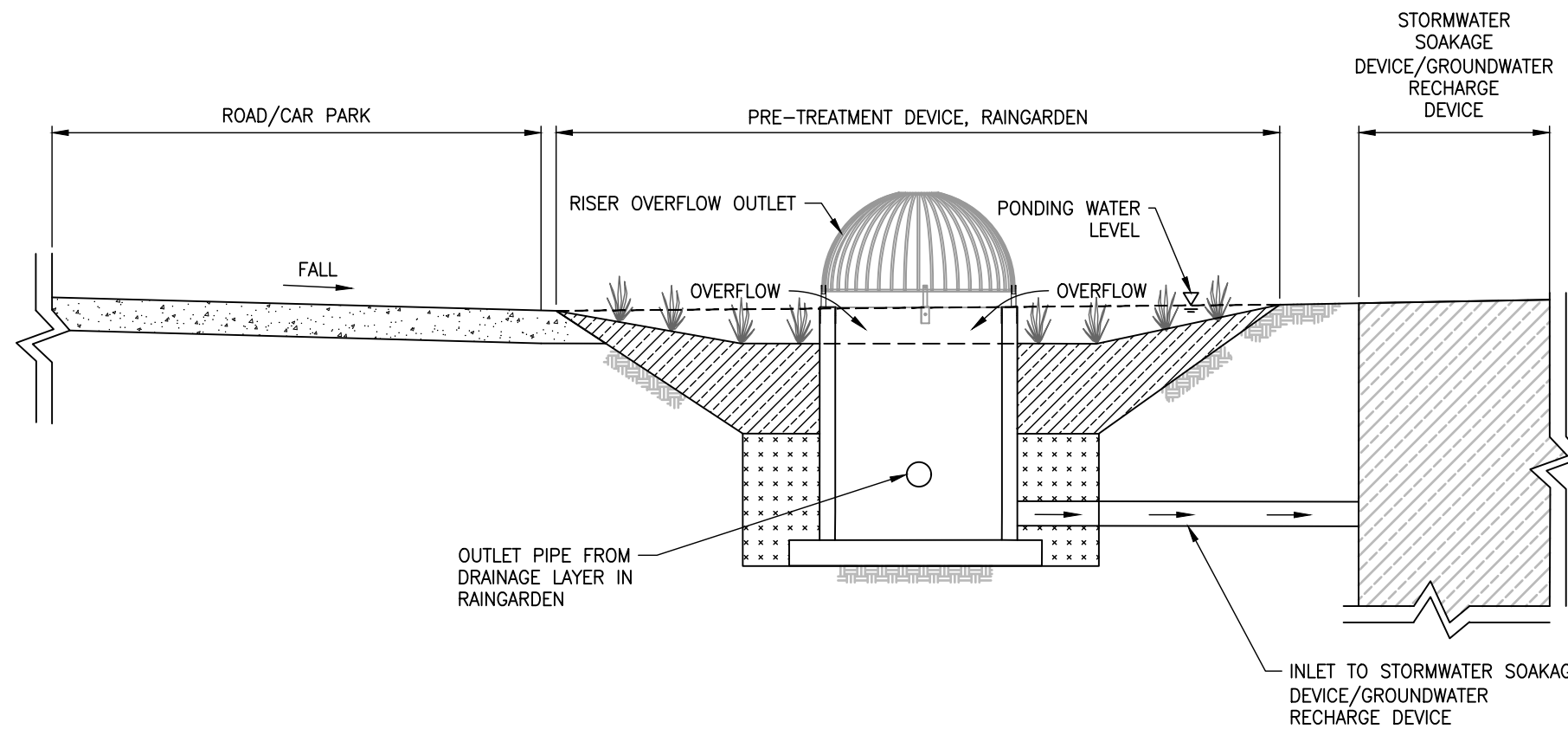

**EXAMPLE OF PRE-TREATMENT WITH RAINGARDEN**

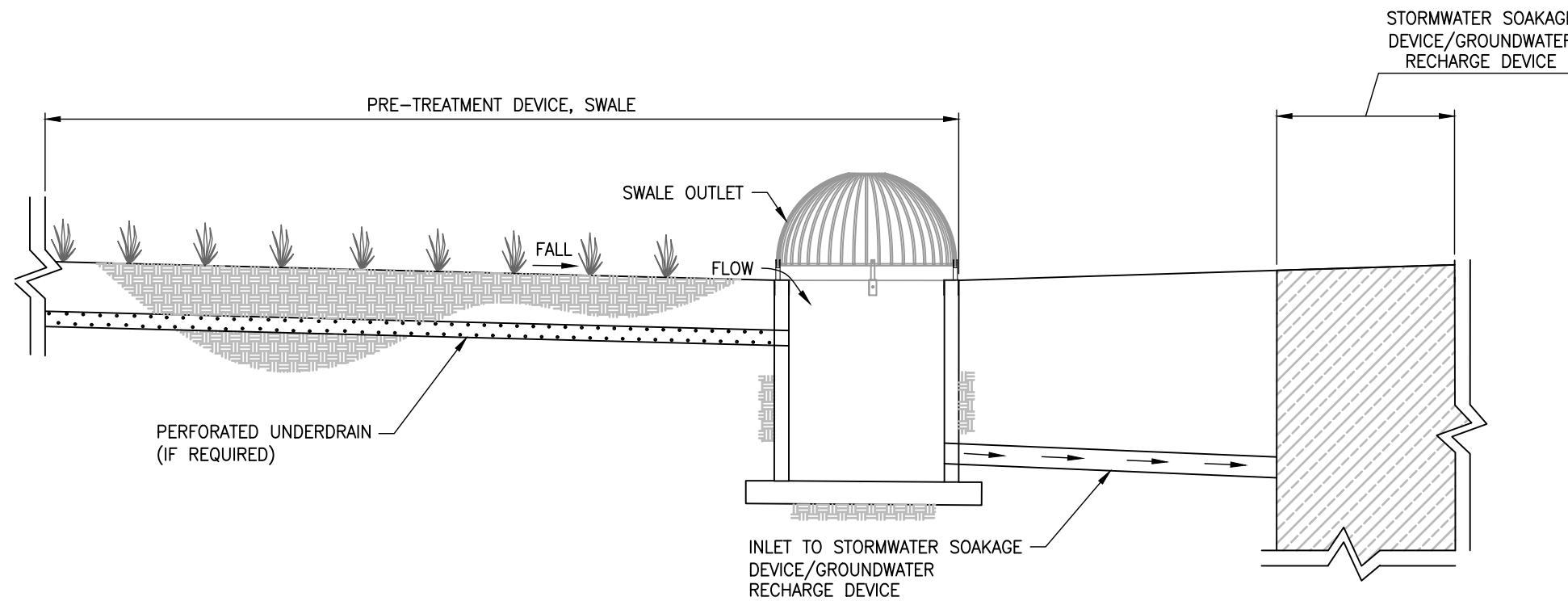

**EXAMPLE OF PRE-TREATMENT WITH SWALE**

PLOT DATE 23/6/2021 11:06 am U:\COO\IES\ETS\2. DTG\3. Guidance docs\GD07 - Soakage\Drawings\CAD\GD07\_11.dwg

SOAKAGE GUIDELINE DOCUMENT  
STANDARD DETAILS  
REVISION: 0  
REV DATE: 21/06/2021  
CAD FILENAME: GD07\_11.DWG

**AUCKLAND COUNCIL**

**EXAMPLES OF PRE-TREATMENT DEVICES  
FOR HIGH CONTAMINANT GENERATING SOURCES (ROADS, CAR PARKS)**

ENVIRONMENTAL-SW



ORIGINAL SCALE	A3
SCALE: N.T.S.	
DRAWING SET	SHEET
GD07	1 OF 1
DRAWING No.	REV
GD07_11	0







# Bibliography

A

B

C



## Bibliography

- Auckland City Council. (2003). *Soakage Design Manual*. Auckland: Auckland City Council. Retrieved from [https://www.drainage.nz/wp-content/uploads/2015/01/auckland\\_soakhole\\_design\\_manual.pdf](https://www.drainage.nz/wp-content/uploads/2015/01/auckland_soakhole_design_manual.pdf)
- Auckland Council. (2013). *TR2013/40 Stormwater Disposal via Soakage in the Auckland Region*. Auckland: Auckland Council. Retrieved from <http://knowledgeauckland.org.nz/assets/publications/TR2013-040-Stormwater-disposal-via-soakage-in-the-Auckland-region.pdf>
- Auckland Council. (2015). *Code of Practice for Land Development and Subdivision, Chapter 4 - Stormwater*. Auckland: Auckland Council. Retrieved from <http://content.aucklanddesignmanual.co.nz/regulations/codes-of-practice/Documents/Stormwater%20Code%20of%20Practice.pdf>
- Auckland Council. (2015). *GD2015/004 Water Sensitive Design for Stormwater*. Auckland: Auckland Council. Retrieved from <http://content.aucklanddesignmanual.co.nz/regulations/technical-guidance/Documents/GD04%20WSD%20Guide.pdf>
- Auckland Council. (2017). *GD2017/001 Stormwater Management in the Auckland Region*. Auckland: Auckland Council. Retrieved from [http://content.aucklanddesignmanual.co.nz/regulations/technical-guidance/stormwatermanagement/Documents/GD01\\_SWMD.pdf](http://content.aucklanddesignmanual.co.nz/regulations/technical-guidance/stormwatermanagement/Documents/GD01_SWMD.pdf)
- Auckland Council. (2017). *New Zealand Ground Investigation Specification*. Auckland Council. Retrieved from <http://content.aucklanddesignmanual.co.nz/regulations/technical-guidance/Documents/NZ-Ground-Investigation-Specification-Vol-1.pdf>
- Auckland Council. (2018). *Auckland Council GeoMaps*. Retrieved from Auckland Council: <https://geomapspublic.aucklandcouncil.govt.nz/viewer/index.html>
- Auckland Council. (2018). *Auckland Long-Term Plan*. Auckland: Auckland Council. Retrieved from <https://www.aucklandcouncil.govt.nz/plans-projects-policies-reports-bylaws/our-plans-strategies/auckland-plan/about-the-auckland-plan/docsprintdocuments/auckland-plan-2050-print-document.pdf>
- Auckland Council. (2018). *Auckland Plan*. Auckland: Auckland Council. Retrieved from <https://www.aucklandcouncil.govt.nz/plans-projects-policies-reports-bylaws/our-plans-strategies/auckland-plan/about-the-auckland-plan/docsprintdocuments/auckland-plan-2050-print-document.pdf>
- Auckland Council. (2018). *Auckland Unitary Plan*. Auckland: Auckland Council. Retrieved from [http://unitaryplan.aucklandcouncil.govt.nz/pages/plan/Book.aspx?exhibit=AucklandUnitaryPlan\\_Print](http://unitaryplan.aucklandcouncil.govt.nz/pages/plan/Book.aspx?exhibit=AucklandUnitaryPlan_Print)
- Auckland Council. (2019). *Auckland Council GeoMaps*. Retrieved from <https://geomaps.aklc.govt.nz>



- Auckland Regional Council. (1998). *Guidelines for stormwater runoff modelling in the Auckland Region*. Auckland: Auckland Regional Council. Retrieved from <http://www.aucklandcity.govt.nz/council/documents/technicalpublications/TP108%20Part%20A.pdf>
- Auckland Regional Council. (1999). *Guidelines for stormwater runoff modelling in the Auckland Region*. Auckland: Auckland Regional Council. Retrieved from <http://www.aucklandcity.govt.nz/council/documents/technicalpublications/TP108%20Part%20A.pdf>
- Auckland Transport. (2017). *Auckland Transport Code of Practice*. Auckland: Auckland Transport. Retrieved from <https://at.govt.nz/about-us/auckland-transport-code-of-practice/>
- Auckland Transport. (2018). *Auckland Regional Land Transport Plan*. Auckland: Auckland Transport. Retrieved from <https://at.govt.nz/media/1977374/rftp-consultation-single-pages-small.pdf>
- beforeUdig. (2018). *Home*. Retrieved from beforeUdig: <https://www.beforeudig.co.nz/nz/home>
- Edbrooke, S. W. (2001). *Geology of the Auckland area*. Lower Hutt: Institute of Geological and Nuclear Sciences Limited.
- Kermode, L. (1992). *Geology of the Auckland Urban Area*. Lower Hutt: Institute of Geological and Nuclear Sciences Limited. Retrieved from <http://shop.gns.cri.nz/gm2/>
- Ministry for the Environment. (1991). *Resource Management Act*. Wellington: New Zealand Government. Retrieved from <http://www.legislation.govt.nz/act/public/1991/0069/latest/DLM230265.html>
- Ministry of Business, Innovation and Employment & New Zealand Geotechnical Society. (2017). *New Zealand Ground Investigation Specification*. Auckland Council. Retrieved from <http://content.aucklanddesignmanual.co.nz/regulations/technical-guidance/Documents/NZ-Ground-Investigation-Specification-Vol-1.pdf>
- Ministry of Business, Innovation, and Employment. (1992). *Building Regulations*. Wellington: New Zealand Government. Retrieved from <http://www.legislation.govt.nz/regulation/public/1992/0150/latest/DLM162570.html>
- Ministry of Business, Innovation, and Employment. (2004). *Building Act*. Wellington: New Zealand Government. Retrieved from <http://www.legislation.govt.nz/act/public/2004/0072/141.0/DLM306036.html>
- Papakura District Council. (2000). *Takanini South Stormwater Catchment Management Plan*. Auckland: Papakura District Council.
- Papakura District Council. (2010). *Development Code*. Auckland: Papakura District Council. Retrieved from [https://at.govt.nz/media/imported/4307/PDC\\_Dev\\_Code\\_0609.pdf](https://at.govt.nz/media/imported/4307/PDC_Dev_Code_0609.pdf)
- Standards Australia. (2009). *AS 2865-2009 Safe working in confined spaces*. Sydney: Standards Australia.
- Standards New Zealand. (2012). *AS/NZS 1547:2012 On-site domestic wastewater management*. Australia Ltd/ New Zealand Standards.

Transit New Zealand. (2006). *TNZ M/4 Specification for basecourse aggregate*. Wellington: Transit New Zealand.

Woods Ballard, B., Wilson, S., Udale-Clarke, H., Illman, S., Scott, T., Ashley, R., & Kellagher, R. (2015). *Sustainable Drainage Systems Manual C753*. London: CIRIA.

ISBN:

978-1-99-100228-0 (Print)

978-1-99-100229-7 (PDF)